

# 2014-2015 CHEVY 1500

## FRONT BUMPER INSTALLATION INSTRUCTIONS



## SAFETY

**Know safety, no injury. Know injury, no safety. ~Author Unknown**

- **READ ALL SAFETY INSTRUCTIONS BEFORE INSTALLATION**
  - FOLLOW ALL INSTRUCTIONS FOR PROPER ASSEMBLY
  - WEAR APPROPRIATE EYE PROTECTION
  - EXERCISE CARE WHEN LIFTING COMPONENTS
  - USE APPROPRIATE TORQUE FOR BOLTS
  - BLUE THREAD LOCKING COMPOUND IS RECOMMENDED ON ALL BOLTS

California Proposition 65



**WARNING**

Cancer and Reproductive Harm

[www.P65Warnings.ca.gov](http://www.P65Warnings.ca.gov)

DO NOT PAINT OVER THIS LABEL. REPLACE IF DAMAGED OR LOST

DKB150\_00



## 2014-2015 CHEVY1500 FRONT

<b>Suggested Torque Values For Steel Grade 5 Standard Bolts</b>		
BOLT DIAMETER (INCH)	THREADS PER INCH	TORQUE (POUND - FEET)
1/4	20	7
5/16	18	14
3/8	16	25
7/16	14	40
1/2	13	60
9/16	12	88
5/8	11	120
3/4	10	200
7/8	9	302
1	8	466

<b>Suggested Torque Values For Steel Grade 8.8 Metric Bolts</b>		
BOLT DIAMETER (mm)	THREAD PITCH (mm)	TORQUE (POUND-FEET)
6	1.0	7
8	1.25	16
10	1.5	32
12	1.75	55
14	2.0	88
16	2.0	140
18	2.5	195
20	2.5	275
22	2.5	375
24	3.0	475

### I. PARTS LIST

ITEM NO.	QTY.	PART NUMBER	DESCRIPTION
1	1	60A-56-0212	600-56-0212 ASSEMBLED
2	4	316-01-0005	1.25" PLUG BT-FLUSH LDPE BLACK
3	1	601-56-2153	PAINTED PASS FRAME MOUNT
4	1	601-56-2154	PAINTED DRIVER FRAME MOUNT
5	1	601-56-2155	PAINTED PASS LOWER FRAME MOUNT
6	1	601-56-2156	PAINTED DRIVER LOWER FRAME MOUNT
7	1	60K-56-0001	HARDWARE KIT #1



## 2014-2015 CHEVY1500 FRONT

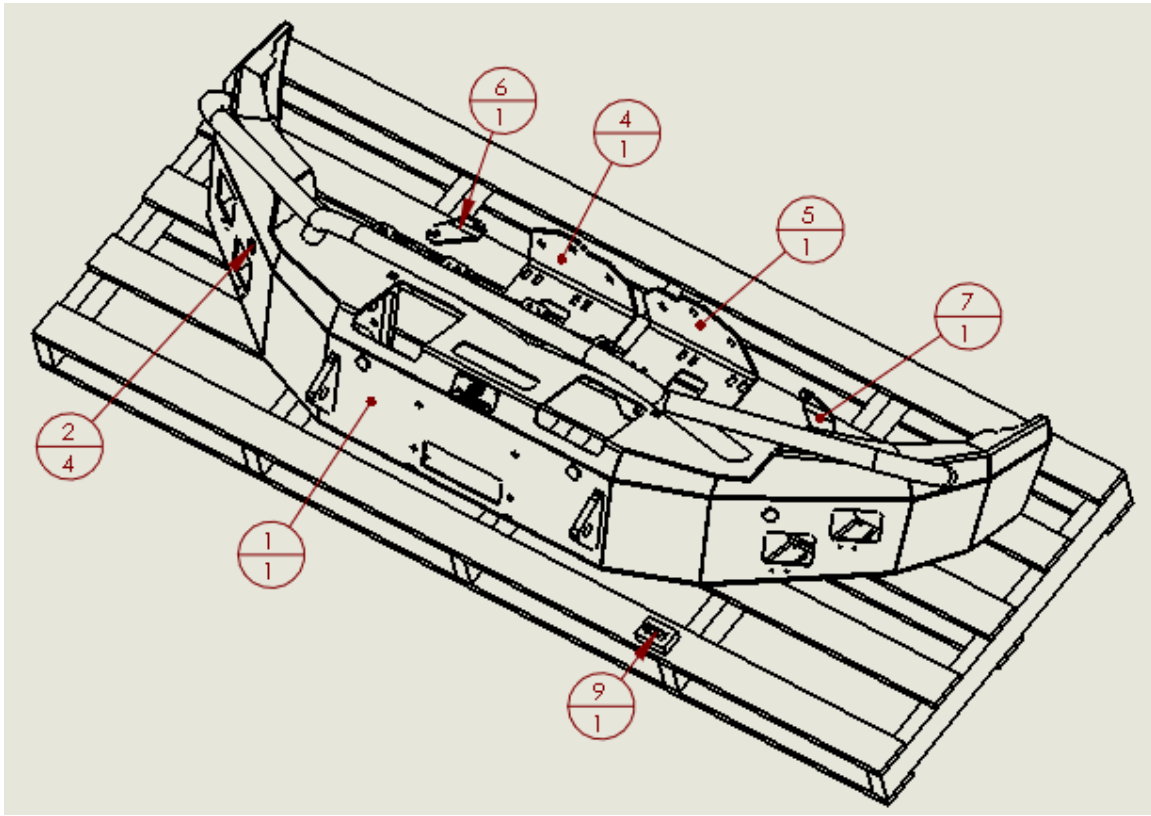

## II. TOOL LIST

1. 15mm socket
2. 18mm socket
3. 15mm wrench
4. 18mm wrench
5. T15 Torx bit
6. 7mm socket
7. Flathead screwdriver

## III. REMOVAL OF OEM BUMPER

1. Remove two screws holding on plastic trim piece with 7mm socket. (orange arrows) Also, remove one screw holding on fenderwell with a T15 Torx bit. (yellow arrow) (both sides)



## 2014-2015 CHEVY1500 FRONT



2. Pull out on edge of plastic trim to release the tabs as shown. Pull in direction of arrows. (both sides)





## 2014-2015 CHEVY1500 FRONT



3. Release six tabs on center of plastic trim below the grill. Have a friend gently pull out on the plastic trim as you release the tabs behind the grill. A flathead screwdriver works well to help pry the tabs. Set aside plastic trim.

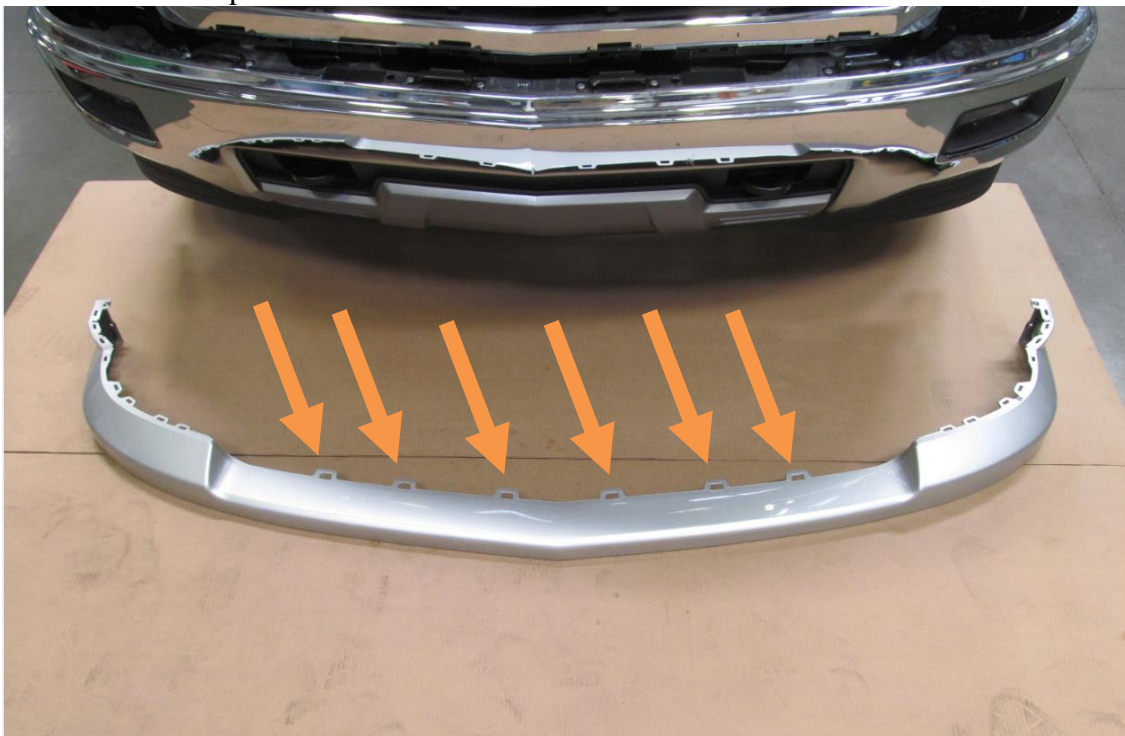



## 2014-2015 CHEVY1500 FRONT

4. Open hood and remove 12 plastic clips. Remove plastic shroud and gently set aside, it will be reused.

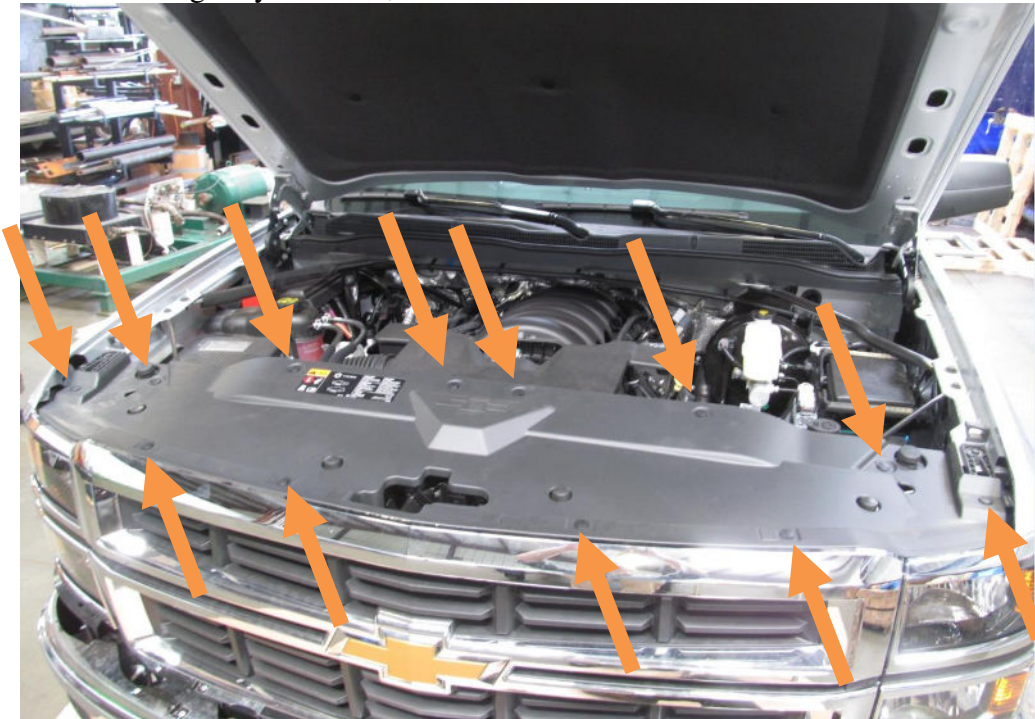

5. Remove four screws on top of grill with 10mm socket.





## 2014-2015 CHEVY1500 FRONT

6. Remove four screws on bottom of grill with 10mm socket.



7. Pull up and out (toward your body) on the top of the grill where the screws were to release the plastic tabs. Using your thumbs to push down on the bracket makes it easy.





## 2014-2015 CHEVY1500 FRONT

8. Pull out on the bottom of the grill to remove it and gently set it aside, it will be reused.
9. Unplug the OEM fog light and sensor wiring harness and place it on top of the factory skid plate out of the way.

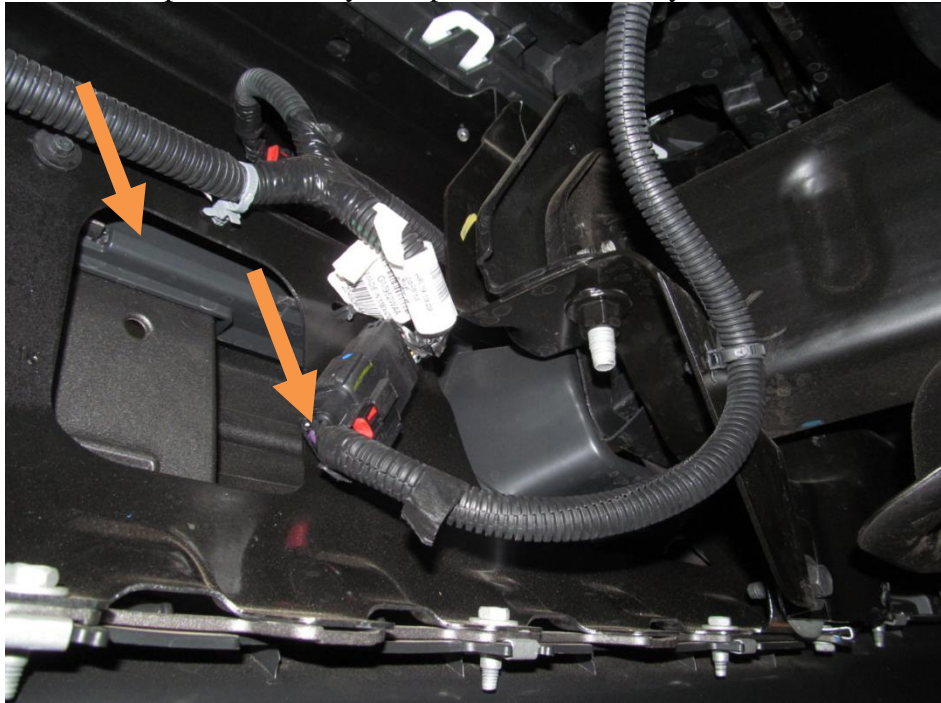





## 2014-2015 CHEVY1500 FRONT

10. Remove three bolts from OEM side bumper support (in front of tires) with 15mm socket. (both sides)

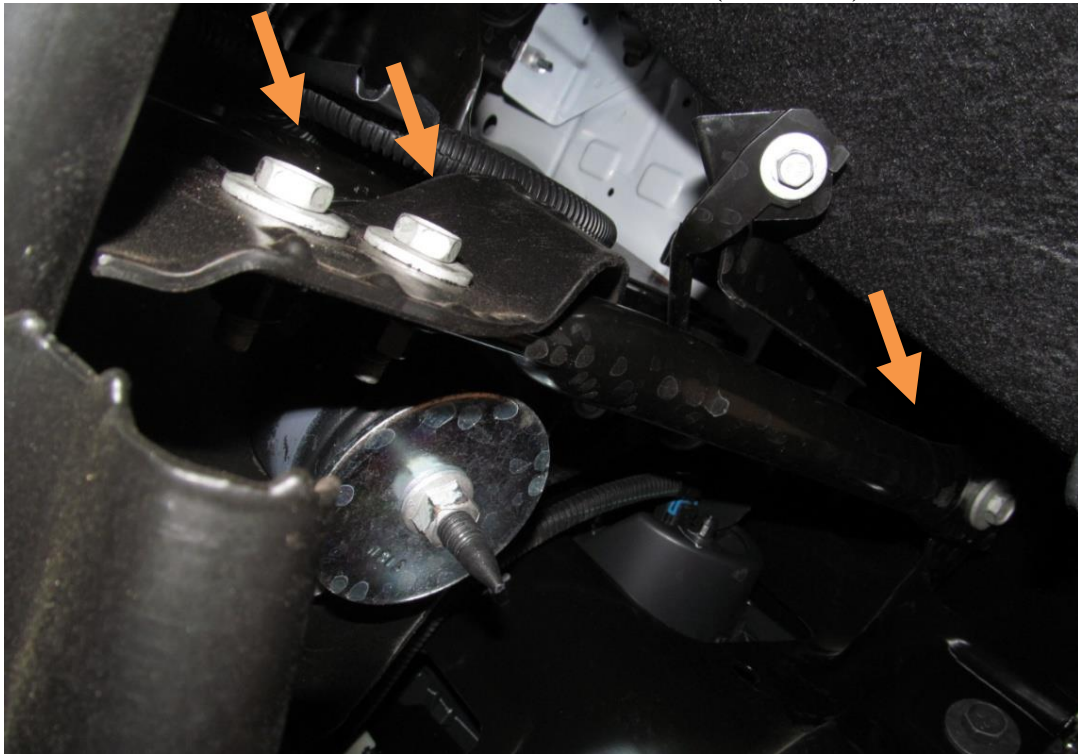



## 2014-2015 CHEVY1500 FRONT

11. Remove four OEM bumper bolts with 18mm socket.

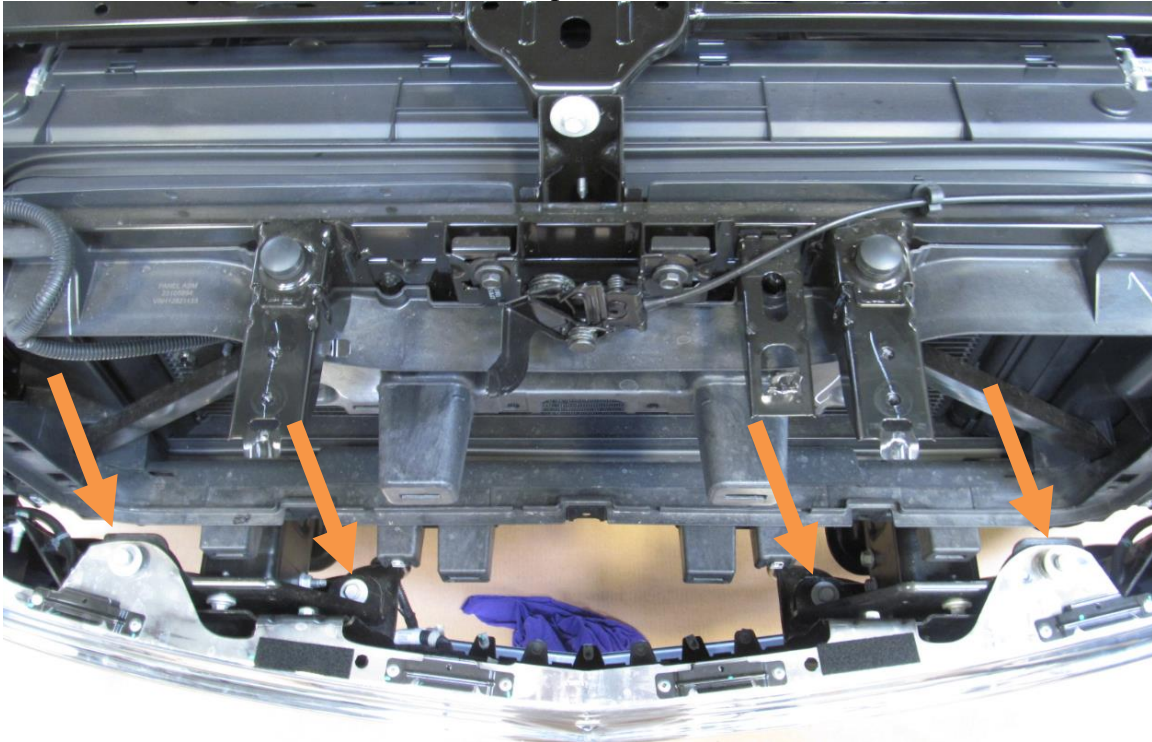

12. Remove OEM bumper and set aside.

13. Remove six bolts holding on OEM frame flanges to frame with 15mm socket. Set brackets aside.





## 2014-2015 CHEVY1500 FRONT

14. Remove two bolts holding on OEM tow hooks with 18mm socket and wrench. (both sides) Set tow hooks aside.

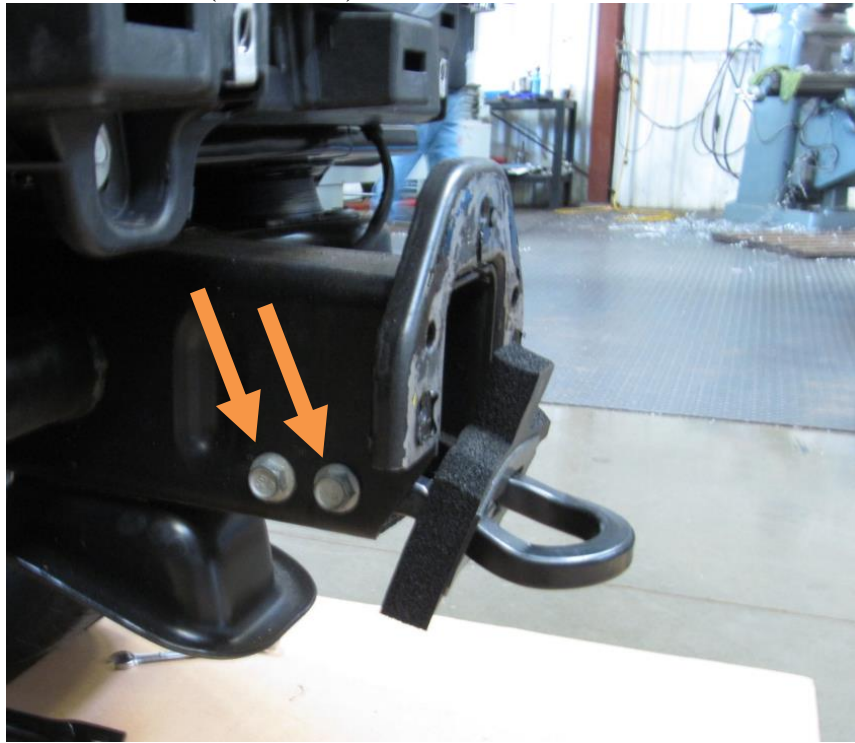

15. Remove three screws holding on plastic trim bracket on fender with a 7mm socket. Set bracket aside. (both sides)





## 2014-2015 CHEVY1500 FRONT



16. Remove two screws holding on plastic trim under headlight with T15 Torx bit. Set bracket aside. (both sides)





## 2014-2015 CHEVY1500 FRONT



17. Replace OEM grill.
18. Remove OEM sensors, grommets, and wiring harness from OEM bumper.



## 2014-2015 CHEVY1500 FRONT

### IV. INSTALLATION OF HAMMERHEAD BUMPER

1. Install Hammerhead frame mounts (601-56-2153 and 2155) with OEM hardware and loosely tighten. USE BOTTOM SLOTS FOR BOLTS  
The bumper's left to right adjustment will be done with these mounts.



2. Install Hammerhead lower frame mounts (601-56-2154 and 601-56-2156) and loosely tighten. Use OEM hardware for thru frame bolt and use two ½"-13 x 2" bolts, four flat washers, two lock washers and two nuts from Hardware kit #1 bolt for the lower bolts. (orange arrow).

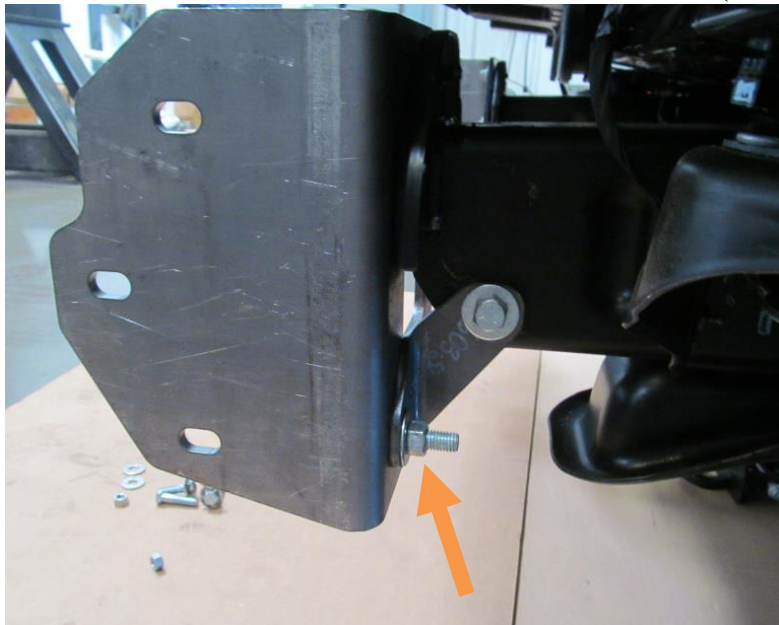



## 2014-2015 CHEVY1500 FRONT

3. Install OEM sensor grommets, sensors and wiring harness in Hammerhead bumper.
4. Install and align Hammerhead bumper using six ½” -13 x 2” bolts, 12 flat washers, six lock washers and six nuts from Hardware Kit #1. Adjust bumper left to right and tighten OEM hardware on frame and lower mount bolt. Adjust bumper up and down and in and out then completely tighten all frame mount to bumper hardware.



Congratulations! Your installation is now complete.  
Thank you for your purchase.