

2007-20XX TOYOTA TUNDRA

FRONT BUMPER INSTALLATION INSTRUCTIONS



SAFETY

Know safety, no injury. Know injury, no safety. ~Author Unknown

- **READ ALL SAFETY INSTRUCTIONS BEFORE INSTALLATION**
 - FOLLOW ALL INSTRUCTIONS FOR PROPER ASSEMBLY
 - WEAR APPROPRIATE EYE PROTECTION
 - EXERCISE CARE WHEN LIFTING COMPONENTS
 - USE APPROPRIATE TORQUE FOR BOLTS
 - BLUE THREAD LOCKING COMPOUND IS RECOMMENDED ON ALL BOLTS

California Proposition 65



WARNING

Cancer and Reproductive Harm

www.P65Warnings.ca.gov

DO NOT PAINT OVER THIS LABEL. REPLACE IF DAMAGED OR LOST

DKB150_00



2007-20XX TOYOTA TUNDRA FRONT BUMPER

Suggested Torque Values For Steel Grade 5 Standard Bolts		
BOLT DIAMETER (INCH)	THREADS PER INCH	TORQUE (POUND - FEET)
1/4	20	7
5/16	18	14
3/8	16	25
7/16	14	40
1/2	13	60
9/16	12	88
5/8	11	120
3/4	10	200
7/8	9	302
1	8	466

Suggested Torque Values For Steel Grade 8.8 Metric Bolts		
BOLT DIAMETER (mm)	THREAD PITCH (mm)	TORQUE (POUND-FEET)
6	1.0	7
8	1.25	16
10	1.5	32
12	1.75	55
14	2.0	88
16	2.0	140
18	2.5	195
20	2.5	275
22	2.5	375
24	3.0	475

I. PARTS LIST

ITEM NO.	QTY.	PART NUMBER	DESCRIPTION
1	2	316-01-0004	1.00" PLUG BT-FLUSH LDPE BLACK
2	4	318-12-0005	0.188" X 0.125" AL POP RIVET
3	1	601-56-9992	BLACK HAMMERHEAD LABEL W/ HOLES
4	1	60A-56-0098	600-56-0098 ASSEMBLED
5	1	60K-56-0001	HARDWARE KIT #1
6	1	60P-56-1595	DRIVER FRAME MOUNT WELDMENT
7	1	60P-56-1596	PASS FRAME MOUNT WELDMENT



2007-20XX TOYOTA TUNDRA FRONT BUMPER

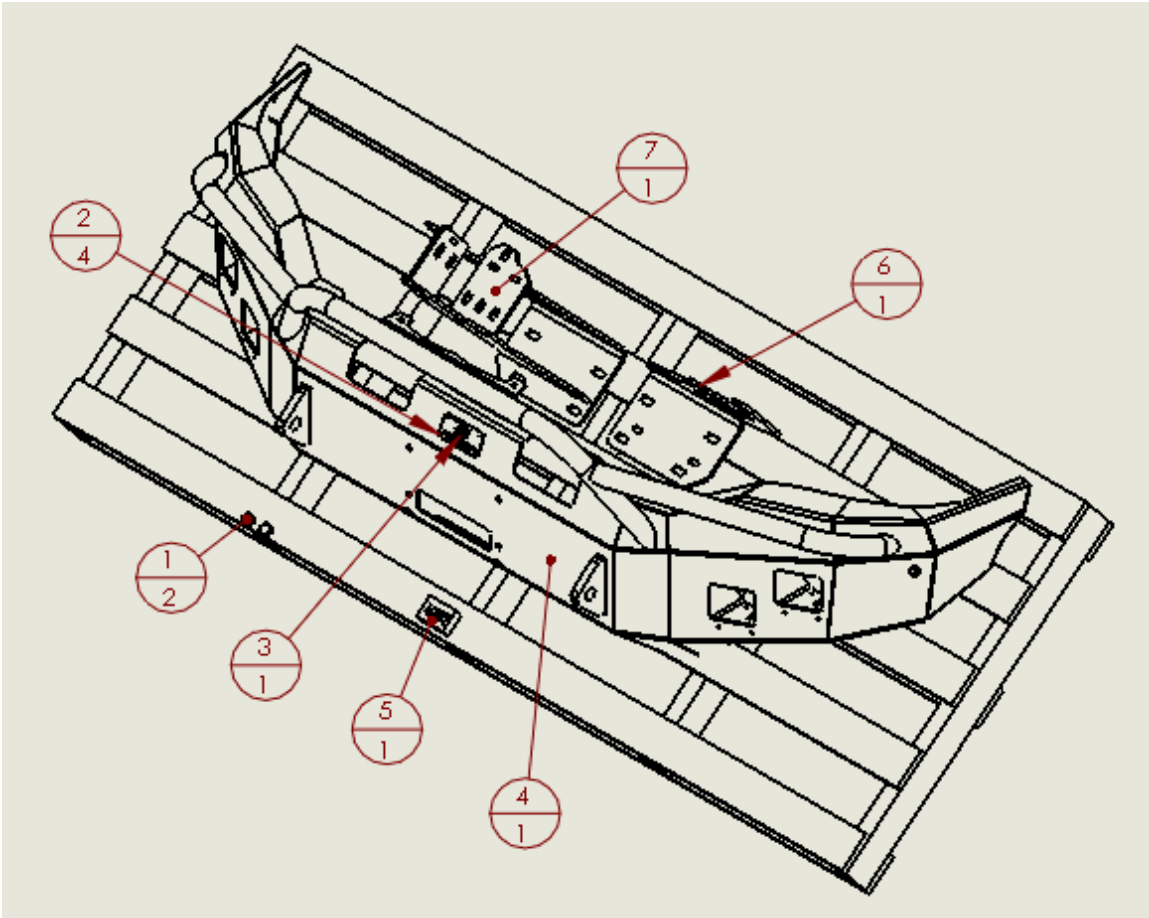

II. TOOL LIST

1. PHILLIPS HEAD SCREW DRIVER
2. FLAT HEAD SCREW DRIVER
3. 10MM WRENCH/SOCKET
4. 17MM WRENCH/SOCKET
5. 14MM WRENCH/SOCKET
6. ¾" WRENCH/SOCKET



2007-20XX TOYOTA TUNDRA FRONT BUMPER

III. REMOVAL OF OEM BUMPER

1. USING PHILLIPS HEAD REMOVE TWO SCREWS IN THE FENDER WHEEL (BOTH SIDES). SEE FIGURE 1 AND FIGURE 2.



FIGURE 1:



FIGURE 2:



2007-20XX TOYOTA TUNDRA FRONT BUMPER

2. USING FLAT HEAD SCREW DRIVER REMOVE 2 CLIPS UNDERNEATH HEADLIGHT.(BOTH SIDES) SEE FIGURE 3.



FIGURE 3:

3. GENTLY REMOVE COVER UNDER HEAD LIGHT (TAKE EXTREME CAUTION WITH THIS PIECE)(BOTH SIDES). SEE FIGURE 4

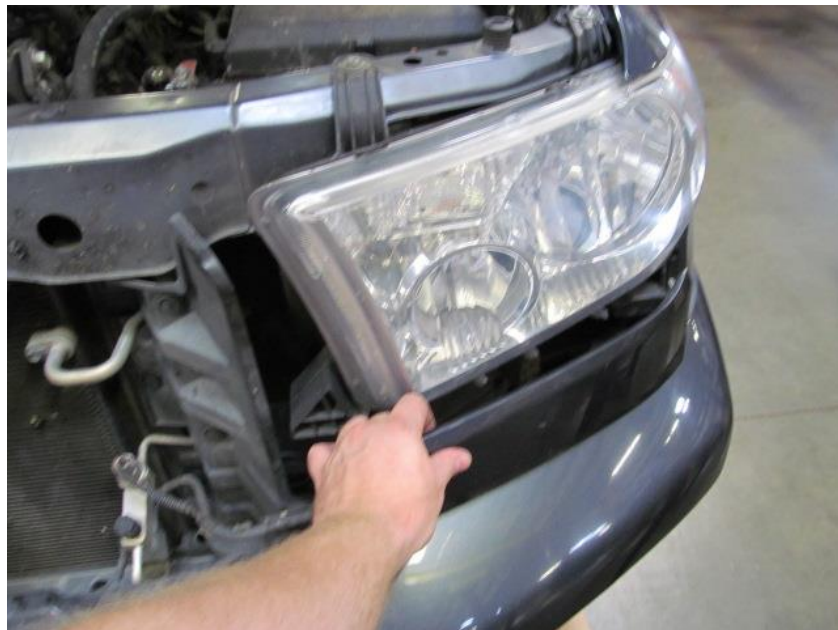

FIGURE 4:



2007-20XX TOYOTA TUNDRA FRONT BUMPER

4. REMOVE TWO CLIPS FROM NEWLY EXPOSE COMPARTMENT (BOTH SIDES) SEE FIGURE 5.

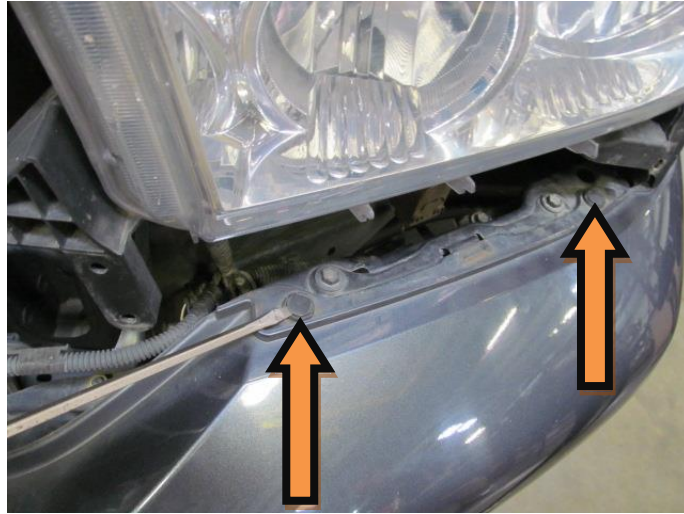

FIGURE 5:

5. REMOVE 4 CLIPS IN THE CENTER OF OEM BUMPER. SEE FIGURE 6 AND FIGURE 7.

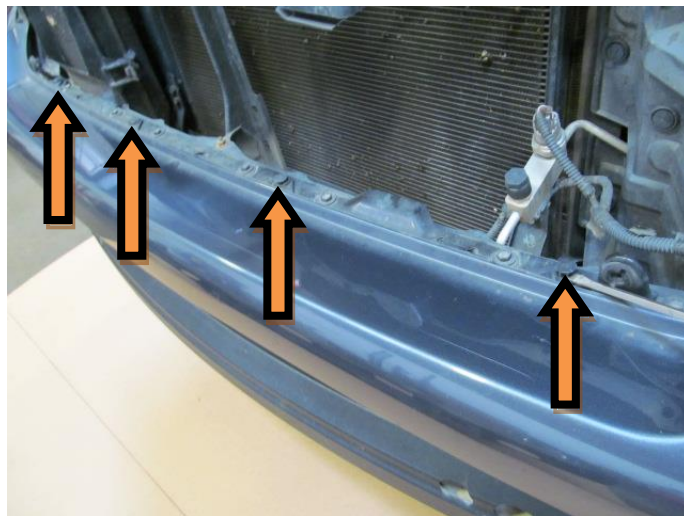

FIGURE 6:



2007-20XX TOYOTA TUNDRA FRONT BUMPER



FIGURE 7:

6. USING A 10MM SOCKET REMOVE TWO BOLTS UNDER THE HEADLIGHT COMPARTMENT (BOTH SIDES)SEE FIGURE 8.



FIGURE 8:

7. RECESSED BEHIND THE LIP IN THE HEADLIGHT COMPARTMENTARE TWO MORE 10MM BOLTS (BOTH SIDES). SEE FIGURE 9



2007-20XX TOYOTA TUNDRA FRONT BUMPER

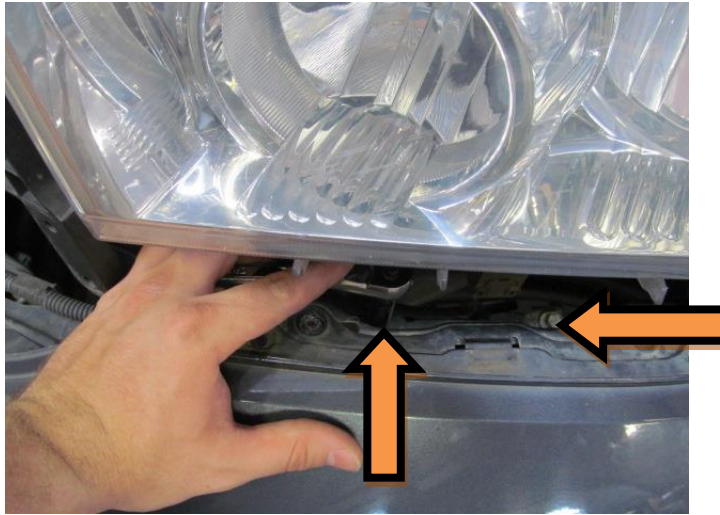

FIGURE 9:

8. IN THE MIDDLE OF BUMPER REMOVE EIGHT 10MM BOLTS. SEE FIGURE 10.



FIGURE 10

9. CAREFULLY REMOVE OEM FACTORY PLASTIC BUMPER.



2007-20XX TOYOTA TUNDRA FRONT BUMPER

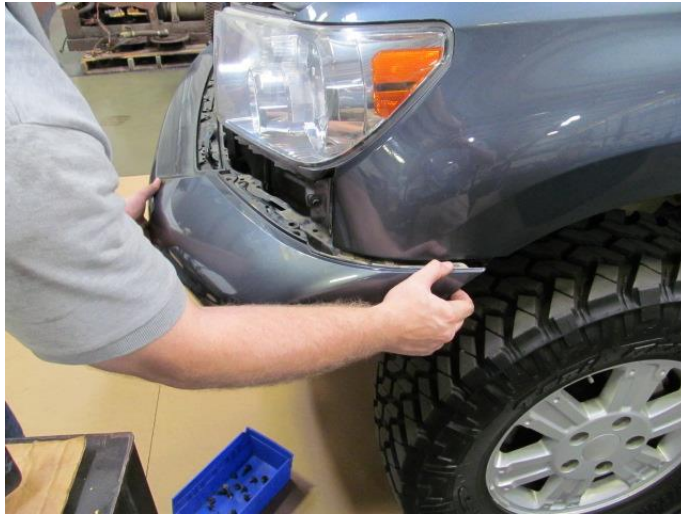

FIGURE 11:

10. REMOVE SIX NUTS WITH 10MM SOCKET.

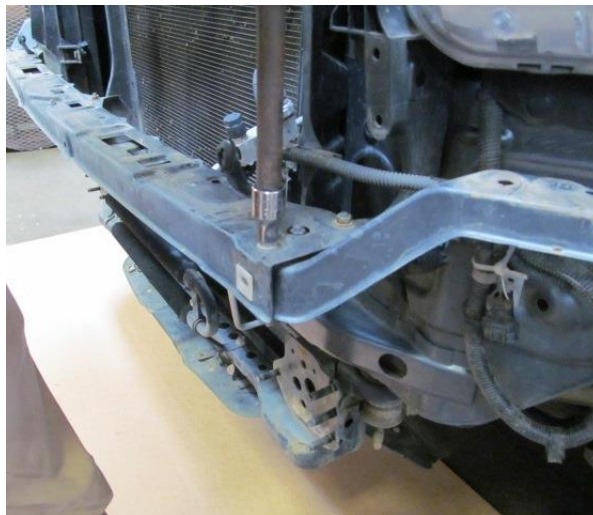

FIGURE 12

11. USING 10MM SOCKET REMOVE TWO NUTS AS SHOWN IN FIGURE 13



2007-20XX TOYOTA TUNDRA FRONT BUMPER



FIGURE 13:

12. USING 10MM SOCKET REMOVE TWO BOLTS SHOWN IN FIGURE 14(BOTH SIDES)



FIGURE 14

13. REMOVE TWO NUTS WITH 10MM SOCKET (BOTH SIDES)



2007-20XX TOYOTA TUNDRA FRONT BUMPER



FIGURE 15

14. REMOVE ALL BUMPER SUPPORT STRUCTURE COVER FROM CENTER AND UNDERNEATH HEADLIGHTS.

15. ON TOP OF THE CHROME OEM BUMPER REMOVE TWO BOLTS USING A 12 MM SOCKET (BOTH SIDES)

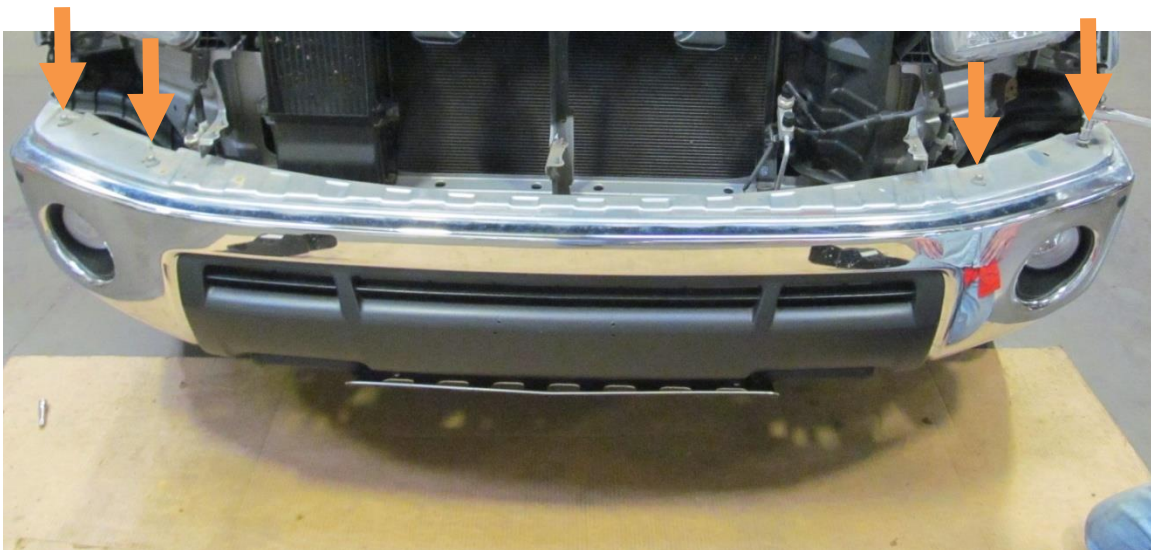

FIGURE 16

16. REMOVE ONE BOLT USING 12MM SOCKET UNDERNEATH OF CHROME BUMPER.



2007-20XX TOYOTA TUNDRA FRONT BUMPER

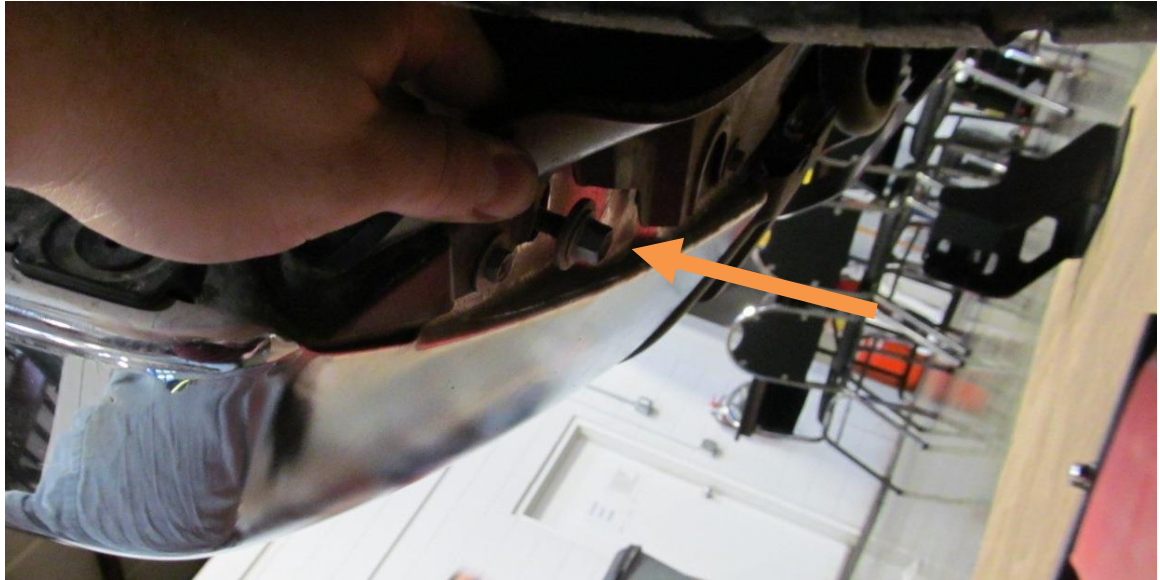

FIGURE 17

17. CAREFULLY REMOVE AND PLACE OEM CHROME BUMPER TO THE SIDE.

18. USING A 17MM SOCKET REMOVE THREE NUTS FROM REINFORCEMENT BUMPER BAR. (BOTH SIDES)SEE FIGURE 18.

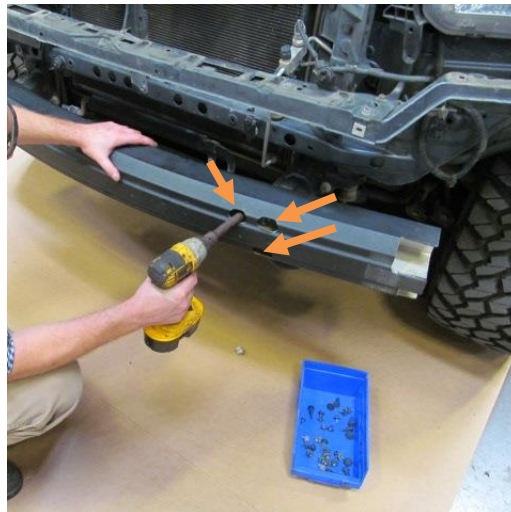

FIGURE 18:



2007-20XX TOYOTA TUNDRA FRONT BUMPER

19. REMOVE FOUR 14MM NUTS FROM FRAME MOUNTS (BOTH SIDES).
SEE FIGURE 19.



FIGURE 19:

20. USING 17MM SOCKET REMOVE TWO BOLTS HOLDING ON OEM TOW
HOOK

IV. INSTALLATION INSTRUCTIONS

1. Position frame mounts as shown in Figures 20 AND 21.



Figure 20: TOP VIEW OF DRIVER SIDE FRAME MOUNT



2007-20XX TOYOTA TUNDRA FRONT BUMPER



FIGURE 21: FRONT VIEW OF DRIVER SIDE FRAME MOUNT

2. USING 17 MM SOCKET TIGHTEN TWO BOLTS THROUGH THE BOTTOM OF FRAME MOUNT.



FIGURE 22: DRIVER SIDE FRAME MOUNT



2007-20XX TOYOTA TUNDRA FRONT BUMPER

3. USING A 14MM SOCKET/WRENCH SECURE FRAME MOUNT TO FRAME. USING OEM NUTS TAKEN OFF DURING REMOVAL INSTRUCTION STEP 19.
4. CAREFULLY ALLIGN BUMPER TO CENTER OF VEHICLE.
5. USING ¾" SOCKET AND WRENCH TIGTHEN 4 BOLTS FROM FRAME MOUNTS INTO BUMPER. (BOTH SIDES)
6. CAREFULLY REINSTALL COVER REMOVED IN REMOVAL OF OEM BUMPER STEP 3.SEE FIGURE 23

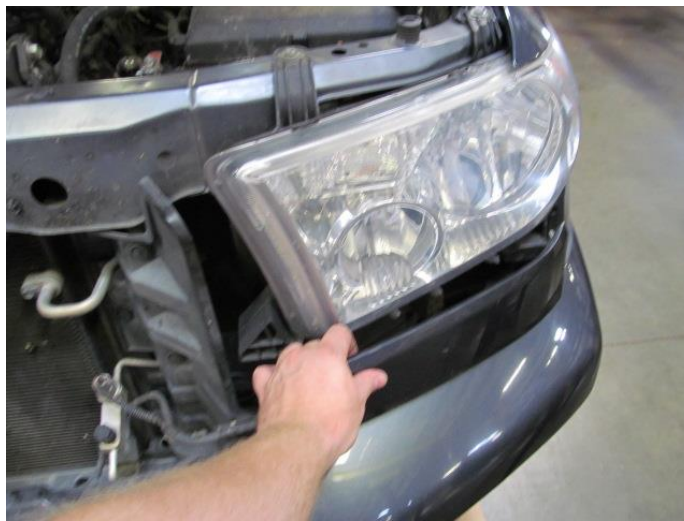

FIGURE 23

CONGRATULATIONS, ENJOY YOUR NEW 2007-20XX PREMIUM AFTERMARKET FRONT BUMPER!

