

# 2007-2017 Jeep Wrangler JK

## MINIMALIST NO BRUSHGUARD WITH 20" SINGLE ROW LED FRONT BUMPER INSTALLATION INSTRUCTIONS



## SAFETY

Know safety, no injury. Know injury, no safety. ~Author Unknown

- **READ ALL SAFETY INSTRUCTIONS BEFORE INSTALLATION**
  - FOLLOW ALL INSTRUCTIONS FOR PROPER ASSEMBLY
  - WEAR APPROPRIATE EYE PROTECTION
  - EXERCISE CARE WHEN LIFTING COMPONENTS
  - USE APPROPRIATE TORQUE FOR BOLTS
  - BLUE THREAD LOCKING COMPOUND IS RECOMMENDED ON ALL BOLTS
  - CHECK TORQUE AFTER FIRST 100 MILES



## 2007-20XX Jeep Wrangler JK Front Bumper

### I. TOOL LIST

1. Phillips head screwdriver
2. 18mm socket
3. 18mm wrench
4. 16mm socket
5. Ratchet
6. 3/4" socket

ITEM NO.	QTY.	PART NUMBER	DESCRIPTION
1	1	601-56-4149	WINCH FAIRLEAD MOUNT
2	2	601-56-4173	SHACKLE MOUNT ASSEMBLY
3	1	60A-56-0697	JP JK MINI FULL GUARD BUMPER FOG LIGHTS
4	1	60K-56-0133	HARDWARE KIT # 133

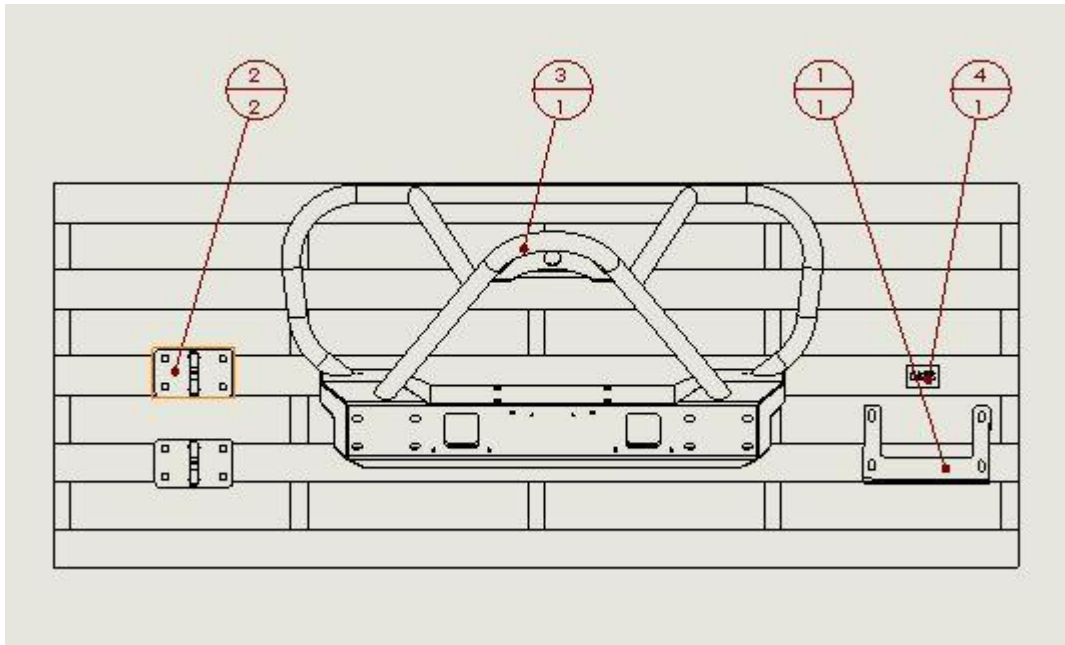



2007-20XX Jeep Wrangler JK Front Bumper

## II. REMOVAL OF OEM BUMPER

1. Using Phillips head screwdriver, remove 4 plastic clips from front of OEM “skid plate”.

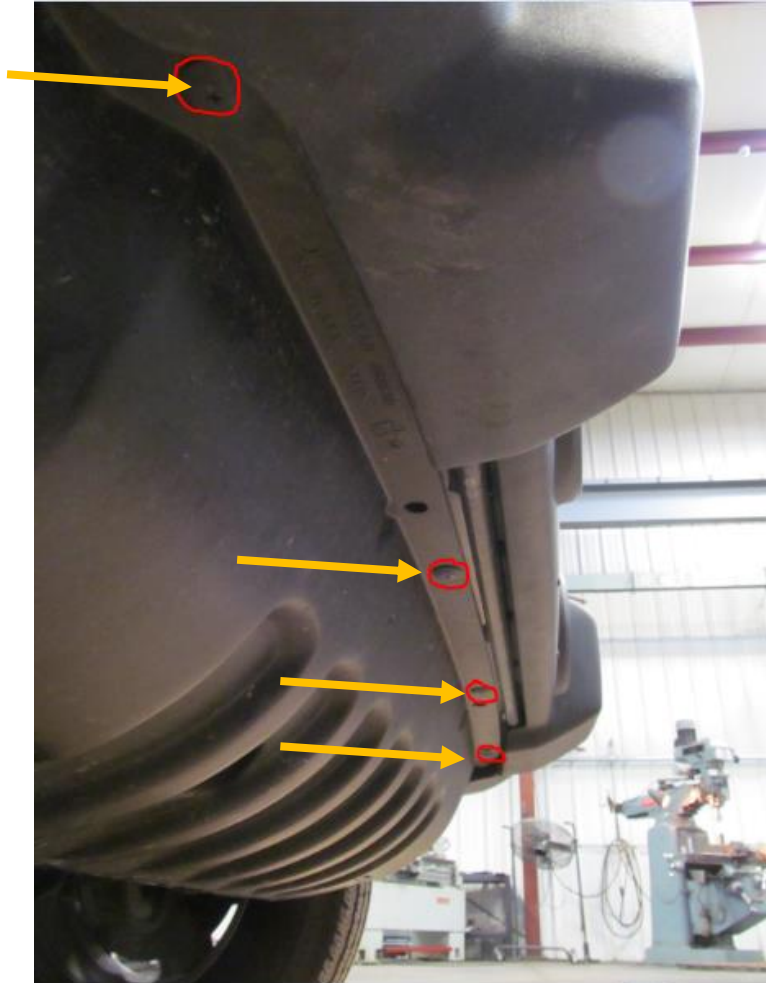



## 2007-20XX Jeep Wrangler JK Front Bumper

2. Using Phillips head screwdriver, remove 2 plastic clips from back of OEM “skid plate.”

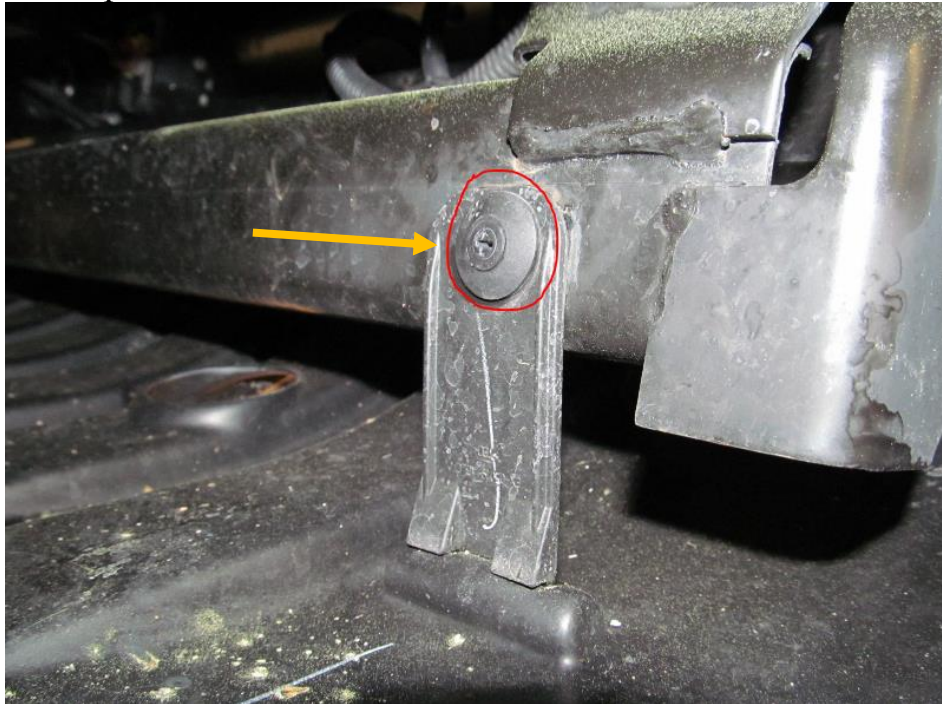

3. Unplug OEM fog lights.







## 2007-20XX Jeep Wrangler JK Front Bumper

- Using 18mm socket and ratchet, remove eight OEM bumper nuts. (4 per side)



- Pull bumper forward and remove OEM fog light clips from OEM bumper.

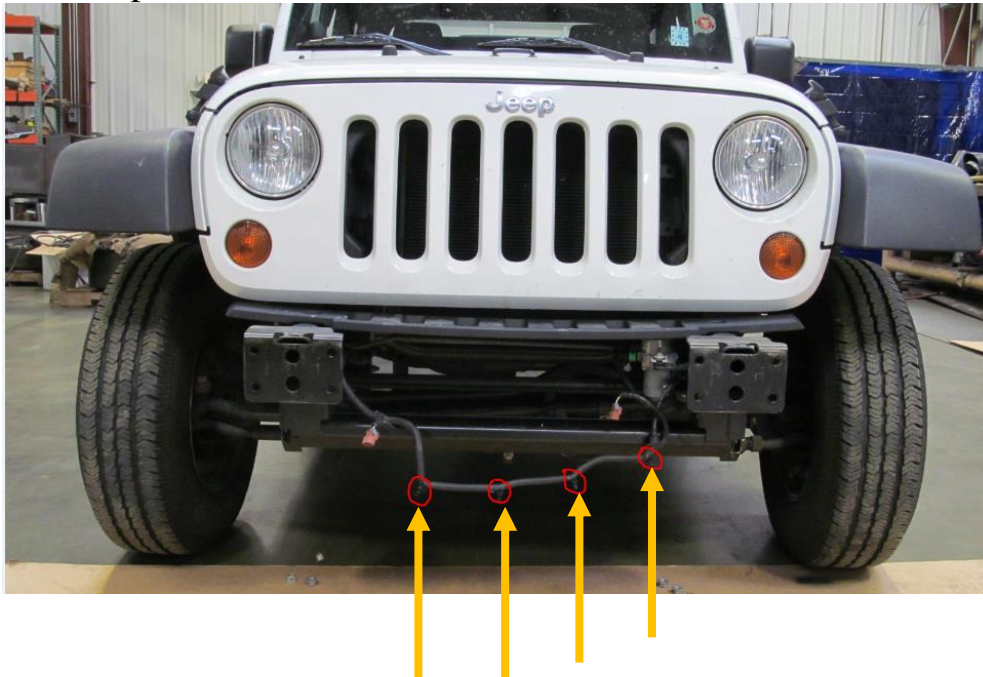



## 2007-20XX Jeep Wrangler JK Front Bumper

### III. INSTALLATION OF HAMMERHEAD BUMPER

1. Install 20" light bar in bumper using the hardware provided with the bar. Gather all the provided hardware for the bumper and both the shackle mounts.



2. If you have the optional skit plat install that on the bumper now with the provided 3 hex head  $\frac{1}{2}$ " bolts. You will use a  $\frac{3}{4}$  wrench and socket.

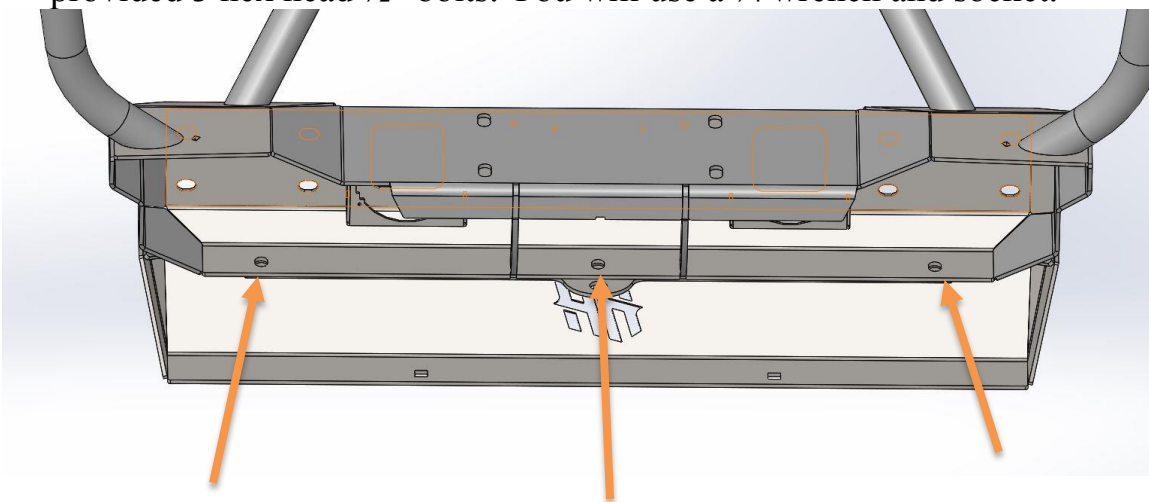



## 2007-20XX Jeep Wrangler JK Front Bumper

3. Lowering the sway bar makes the install of the bumper much easier. Remove the 4 bolts holding the sway bar on with a 16mm socket

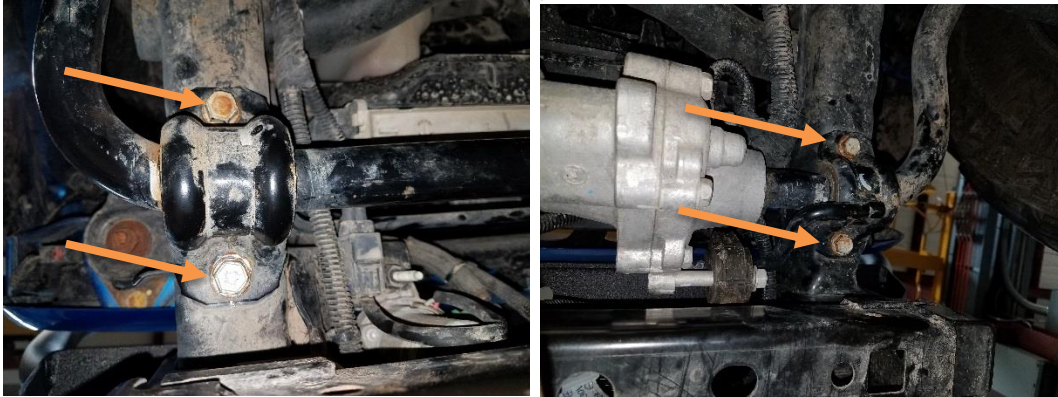

4. Place bumper on Jeep. Using 8 black 1/2" carriage head bolts install the bumper. Bolts go through the shackle mounts, then the bumper. Use the provided 1/2" nuts, washers, and lock washers to secure the bumper.



5. Align bumper and torque all bolts to spec
6. Make sure to replace the 4 bolts on the sway bar and tighten down to spec.
7. If you have the optional skit plate install the provided 2 black carriage head bolts on the bottom using the 2 washers, lock washers, and nuts provided.





2007-20XX Jeep Wrangler JK Front Bumper

## CONGRATULATIONS ON YOUR NEW HAMMERHEAD BUMPER!

Without Skid Plate

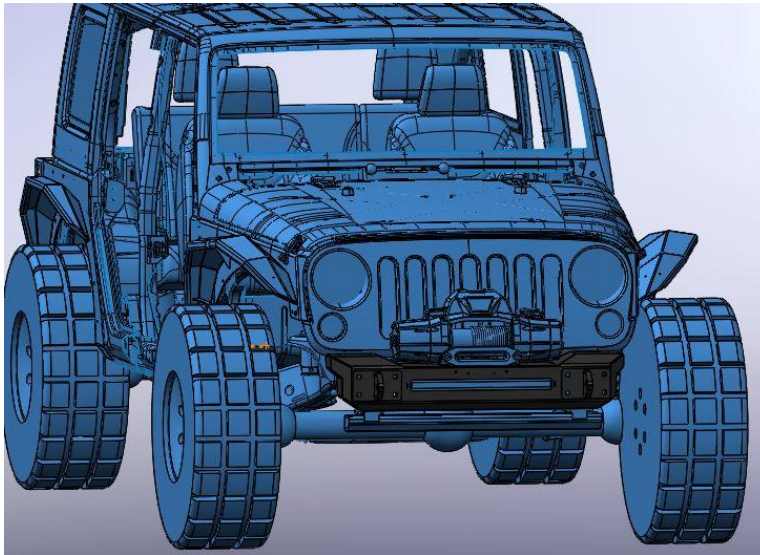

With Skid Plate

