

2020-20XX GMC 2500-3500 WINCH BUMPER

FRONT BUMPER INSTALLATION INSTRUCTIONS



SAFETY

Know Safety, no injury. Know injury, no safety. ~Author Unknown
If there are any questions, call 1-855-HHTOUGH

- **READ ALL SAFETY INSTRUCTIONS BEFORE INSTALLATION**
 - FOLLOW ALL INSTRUCTIONS FOR PROPER ASSEMBLY
 - WEAR APPROPRIATE EYE PROTECTION
 - EXERCISE CARE WHEN LIFTING COMPONENTS
 - USE APPROPRIATE TORQUE FOR BOLTS
 - BLUE THREAD LOCKING COMPOUND IS RECOMMENDED ON ALL BOLTS





600-56-1007, 1008, 1009

Suggested Torque Values For Steel Grade 5 Standard Bolts

BOLT DIAMETER (INCH)	THREADS PER INCH	TORQUE (POUND - FEET)
1/4	20	7
5/16	18	14
3/8	16	25
7/16	14	40
1/2	13	60
9/16	12	88
5/8	11	120
3/4	10	200
7/8	9	302
1	8	466

Suggested Torque Values For Steel Grade 8.8 Metric Bolts

BOLT DIAMETER (mm)	THREAD PITCH (mm)	TORQUE (POUND- FEET)
6	1.0	7
8	1.25	16
10	1.5	32
12	1.75	55
14	2.0	88
16	2.0	140
18	2.5	195
20	2.5	275
22	2.5	375
24	3.0	475

I. PARTS LIST

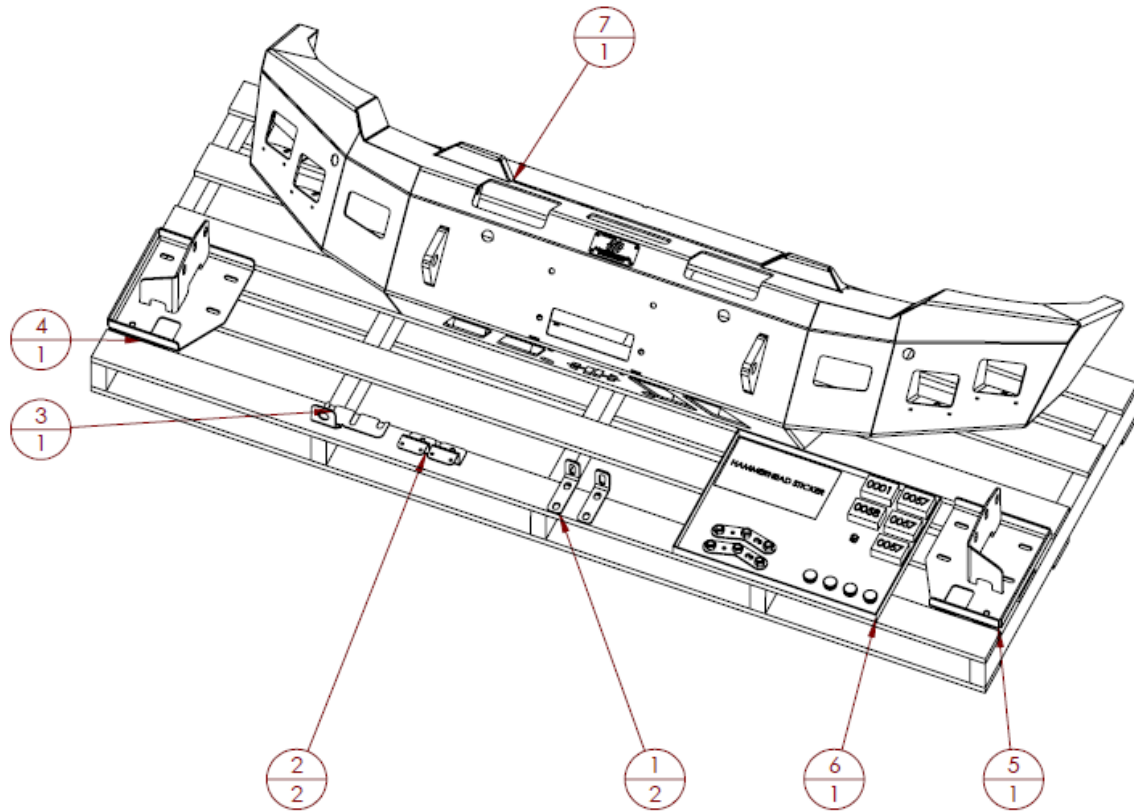

ITEM NO.	QTY.	PART NUMBER	DESCRIPTION
1	2	601-56-4617	LOWER MOUNT
2	2	601-56-4618	SHROUD MOUNT
3	1	601-56-4626	BLOCK HEATER BRACKET
4	1	601-56-5490	RIGHT FRAME MOUNT WELDMENT
5	1	601-56-5491	LEFT FRAME MOUNT WELDMENT
6	1	60H-56-0001	INSTALL KIT #1
7	1	60P-56-1007	600-56-1007 POLISHED



600-56-1007, 1008, 1009

INSTALL KIT #1 PARTS LIST

ITEM NO.	QTY	PART NUMBER	DESCRIPTION	
1	4	316-01-0005	1.25" PLUG BT-FLUSH LDPE BLACK	-
2	1	409-01-0125	HAMMERHEAD STICKER	-
3	1	443-01-0086	LICENSE PLATE MOUNTING KIT	-
4	2	601-56-2868	WELDNUT TAB 3	-
5	1	60K-56-0001	HARDWARE KIT #1	-
6	3	60K-56-0057	HARDWARE KIT #57	-
7	1	60K-56-0058	HARDWARE KIT #58	-

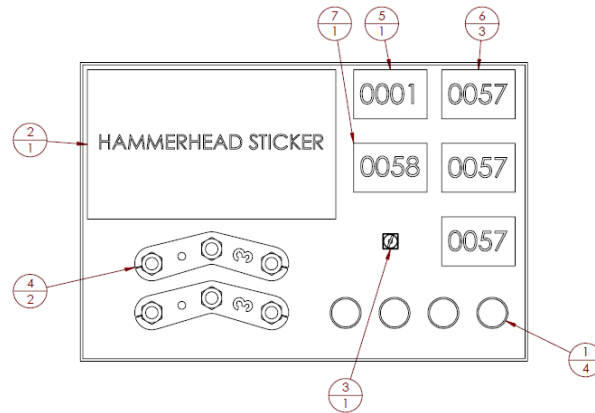

REMOVE CONTENTS FROM BOX AND VERIFY ALL PARTS ARE PRESENT.

If there are any questions, call 1-855 HHTOUGH or email HHORDERS@hammerheadarmor.com

II. TOOL LIST

1. A Good Friend
2. Basic Tool Kit
3. Blue Masking Tape
4. Trim Tool
5. T15 Torx bit
6. 10mm socket (if you can find it)
7. 15mm socket
8. 18mm socket
9. 7mm socket

III. VEHICLE PREPARATION

1. Park vehicle on level surface.
2. Engage parking brake and disconnect battery.
3. Using blue masking tape, mask along the profile of your truck above the bumper. This will help protect your truck from any accidental scratches.

IV. REMOVAL OF OE BUMPER

1. Using trim tool, remove nine Christmas trees attaching the engine shroud.



2. Using T15 Torx bit, remove two screws attaching hood latch release lever to truck. **DO NOT CLOSE HOOD!**



3. Remove engine shroud and temporarily replace hood latch release lever and screws.
4. Using a 10mm socket, remove four bolts attaching the top of the grill to the truck.



600-56-1007, 1008, 1009

5. If equipped with a camera, unplug it. The plug is located on the right side of the grille next to the headlight. You will need to pull out on the top of the grille to access the plug.



6. Use blue masking tape to tape around plastic trim pieces under headlights. Gently pull out on top of grille to release tabs. Then gently pull out on bottom of grille to remove. Set aside.

7. Using 15mm socket, remove three bolts attaching lower bumper brace to truck. Remove brace and set aside. (both sides)



8. If equipped with fog lights or sensors, unplug harness. Plug is located next to the right headlight.



9. If equipped with engine block heater, unplug harness. Plug is located next to the left headlight.



10. Using an 18mm socket, remove four bolts attaching bumper to truck. Remove bumper and set aside.

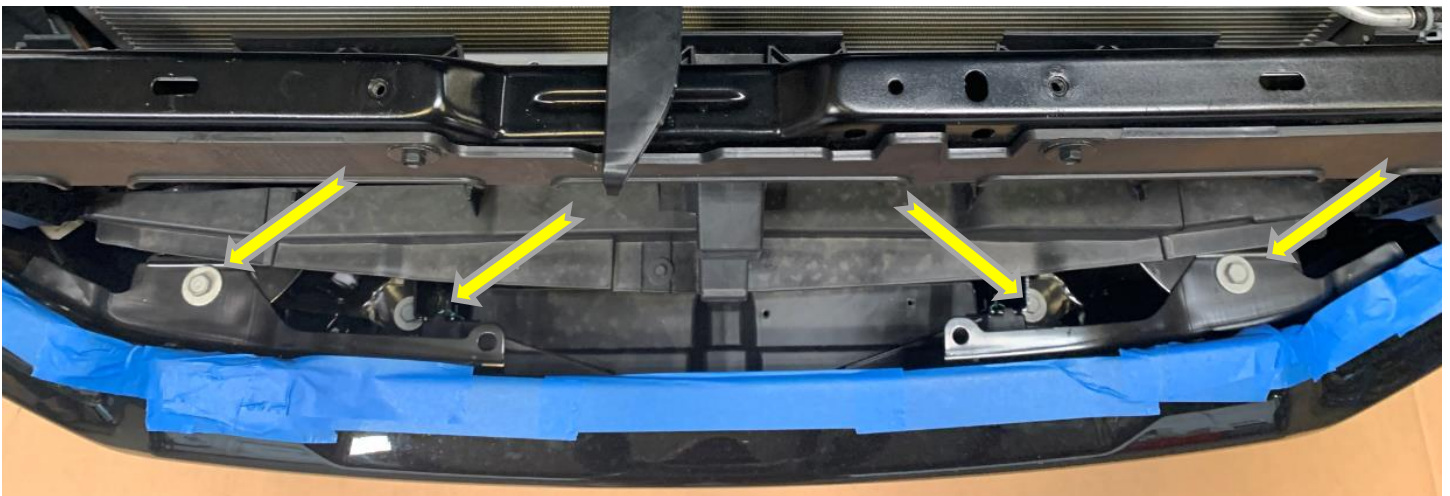

11. Using trim tool, remove two Christmas trees attaching tow hook trim pieces to truck.



12. Using an 18mm wrench and socket, remove two bolts attaching tow hooks to frame. Remove tow hook and set aside. (both sides)

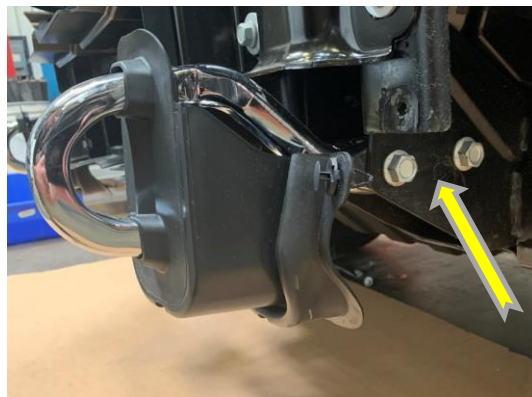

13. Using 7mm socket, remove four bolts attaching louvers to OE bumper mounts.





600-56-1007, 1008, 1009

14. Using 15mm socket, remove eight bolts attaching OE bumper mounts to frame. Set mounts aside.

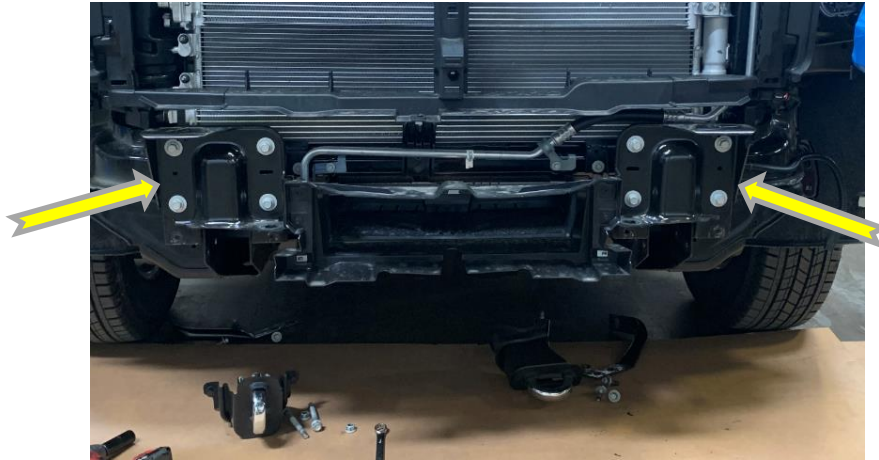

I. INSTALLATION OF HAMMERHEAD BUMPER

1. Reinstall grill and engine shroud.
2. Install all lights and sensors in Hammerhead bumper at this time.
3. Layout frame mounts, louver mounts, and hardware kit as shown.



4. Using OE hardware, install frame mounts and louver mounts as shown.

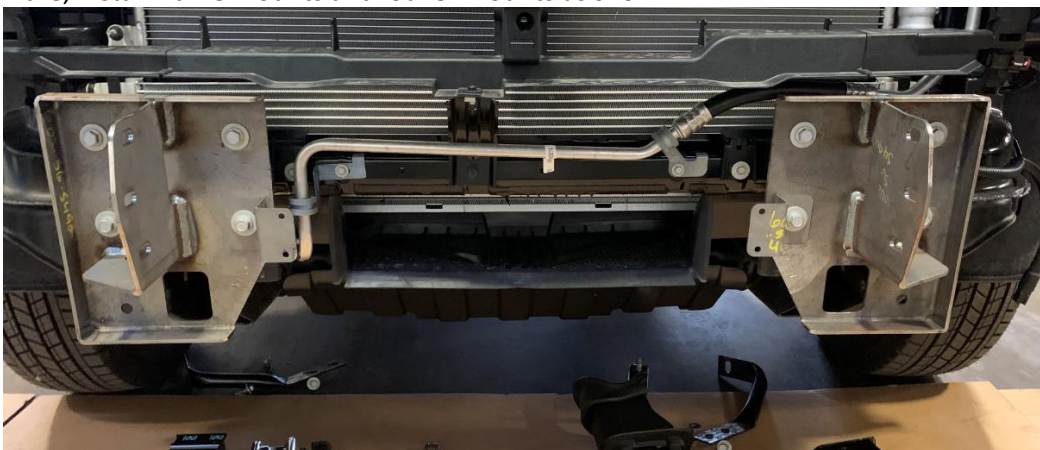



600-56-1007, 1008, 1009

5. Using two hardware kit # 57s install OE louver on mounts.
6. Layout weldnut tab 3 (601-56-2868) and hardware from hardware kit #58 as shown. You will use six ½"-13x1.5" bolts, six ½" flat washers, and six ½" lock washers to attach your Hammerhead bumper to the frame mounts.



7. Using a hoist or a few friends, attach bumper to frame mounts using hardware. Put bolts in from the outside through Hammerhead frame mounts. Use the weldnut tab on the inside. Start all bolts before aligning bumper. Align bumper a minimum of ¼" below headlights. When truck flexes off-road, this distance allows your bumper and body to have clearance. Tighten bolts with ¾" socket or wrench. Tighten frame mount bolts at this time.
10. Trim inner fenders to match bumper.

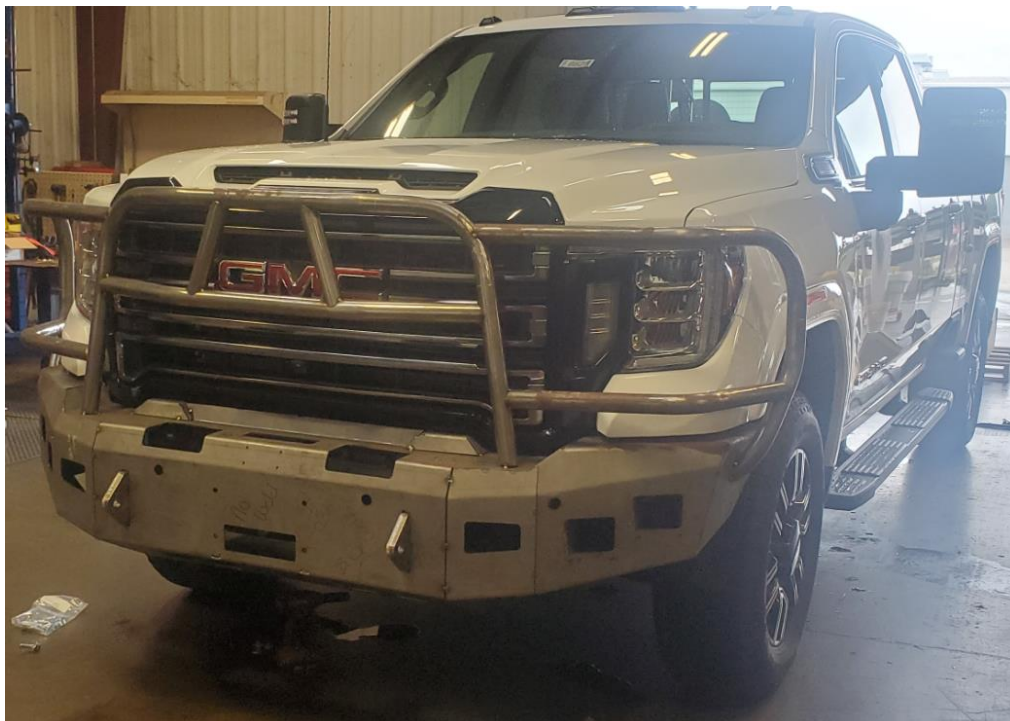

Congratulations! Your Installation is now complete.

Thank You for your purchase!