

INSTALLATION INSTRUCTIONS

PRO SERIES REAR BUMPER



APPLICATION: Silverado/Sierra 1500 2014-2018; Silverado LD/Sierra 1500 Limited 2019, Silverado/Sierra 2500/3500 2015-2019

PART NUMBER:
58-421005

CONTENT			
ITEM	QUANTITY	DESCRIPTION	TOOLS NEEDED
1	1	REAR BUMPER	10MM SOCKET
2	2	FRAME MOUNTING BRACKET (1 DRIVER, 1 PASSENGER)	10MM WRENCH
3	2	BUMPER MOUNTING BRACKET (1 DRIVER, 1 PASSENGER)	19MM SOCKET
4	4	SENSOR L-TAB	19MM WRENCH
5	4	SENSOR HOLE PLUG	RATCHET
6	14	M12 SPLIT LOCK WASHER (YELLOW ZINC)	TORQUE WRENCH
7	14	M12 SERRATED FLANGE BOLT (YELLOW ZINC)	
8	28	M12 FLAT WASHER (YELLOW ZINC)	
9	14	M12 HEX NUT (YELLOW ZINC)	
10	4	M6 FLAT WASHER (YELLOW ZINC)	
11	4	M6 HEX NUT (YELLOW ZINC)	
12	4	M6 CARRIAGE BOLT (YELLOW ZINC)	
13	4	M6 SPLIT LOCK WASHER (YELLOW ZINC)	
14	6	M6 BUTTON HEAD BOLT (BLACK ZINC)	
15	6	M6 SERRATED FLANGE NUT (BLACK ZINC)	
16	6	M6 FLAT WASHER (BLACK ZINC)	

ANTI-SEIZE LUBRICANT MUST BE USED ON ALL STAINLESS STEEL FASTENERS TO PREVENT THREAD DAMAGE AND GALLING

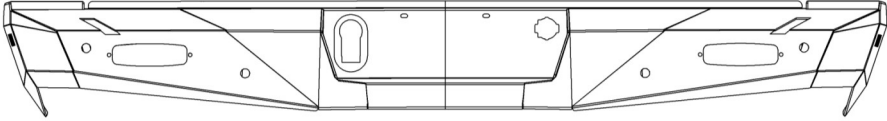
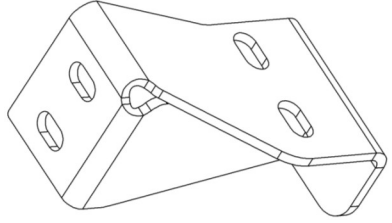
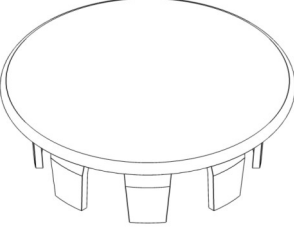
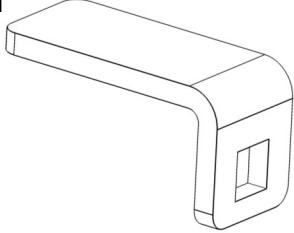
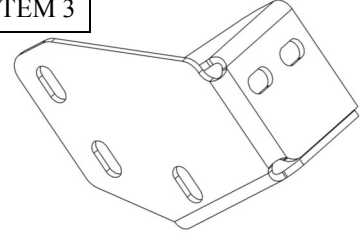
<p>ITEM 1</p> 	<p>ITEM 2</p> 
<p>ITEM 5</p> 	<p>ITEM 4</p>  <p>ITEM 3</p> 

WESTIN Westin Automotive Products, Inc.
320 W. Covina Blvd
San Dimas, Ca. 91773

Thank you for choosing Westin products
for additional installation assistance please call
Customer Service (800) 793-7846
www.westinautomotive.com

PROCEDURE

1. Remove contents from box, verify if all parts listed are present and free from damage.
Carefully read and understand all instructions before attempting installation.
Failure to identify damage before installation could lead to a rejection of any claim.

2. Disconnect license plate lights, trailer connector and park assist sensors so that bumper assembly can be removed.
3. Remove the four bolts indicated in **Figure 1** from the driver's side frame bracket. Repeat on passenger's side.
4. In order to remove the stock bumper, three bolts on each side of the vehicle holding the bed to the frame must be loosened and the bed must be lifted slightly. **Figures 2-4** show the locations of these three bolts on the driver's side. **Note:** Do not remove these bolts. Only loosen them

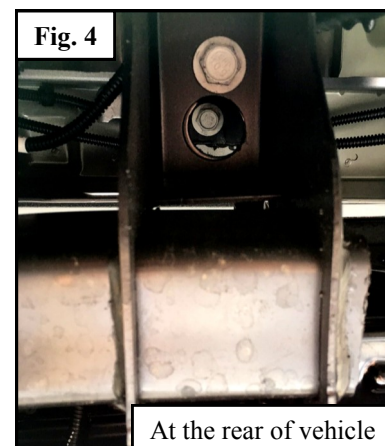
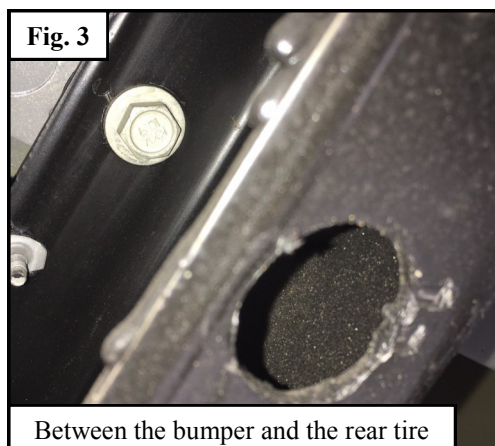
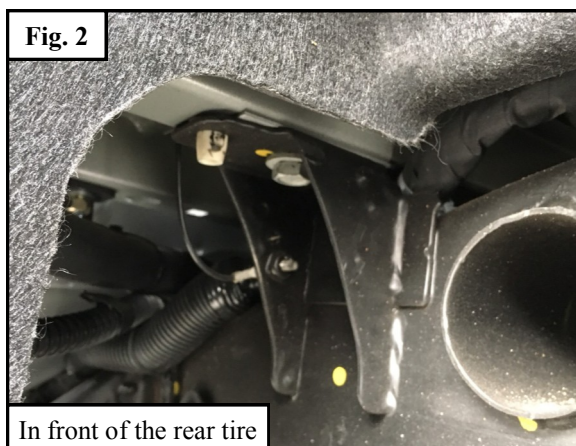
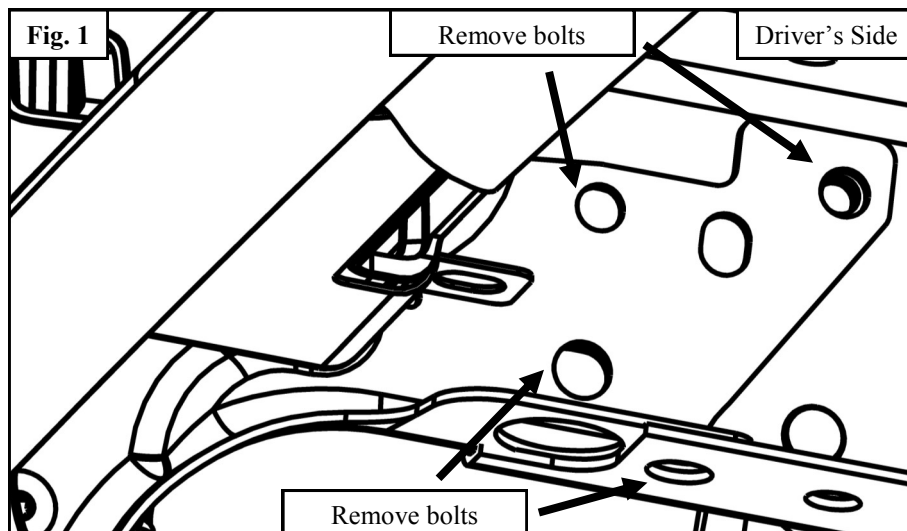

PARKING SENSOR INSTALLATION

***If not installing sensors, install Hole Plugs into holes on bumper and proceed.**

5. Remove the parking sensors from the OEM bumper. Pay attention to the orientation of the sensors. They must be installed in the same orientation. Handle sensors with care, they are very delicate .
6. Use the Sensor Tab (4) along with the supplied M6 Hardware (10-13) to install the sensors as shown in **Figure 4-5**.
7. Carefully route the harness around the bumper.

Note: Zip ties or double sided tape can be used to route harness and to hold the sensor in position.

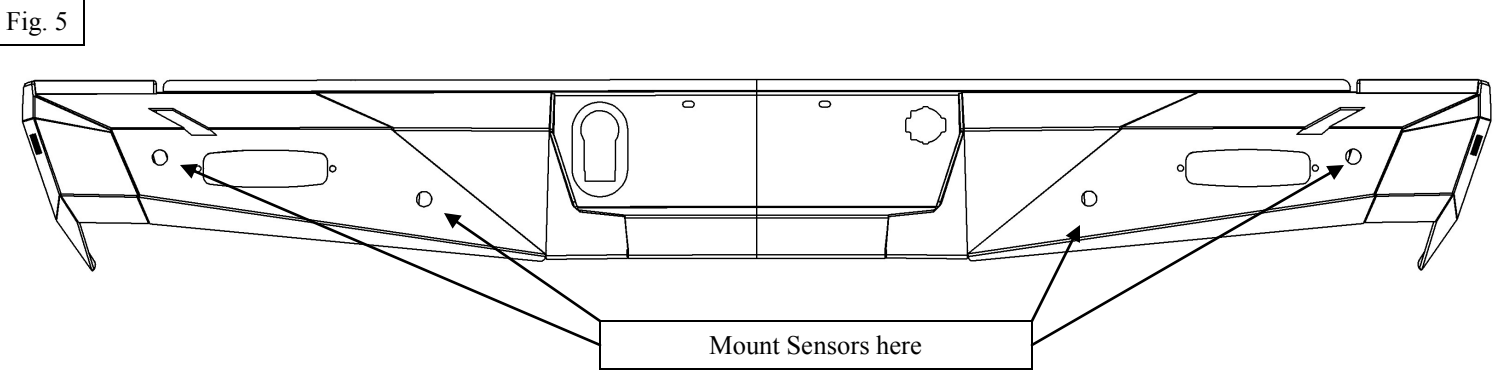
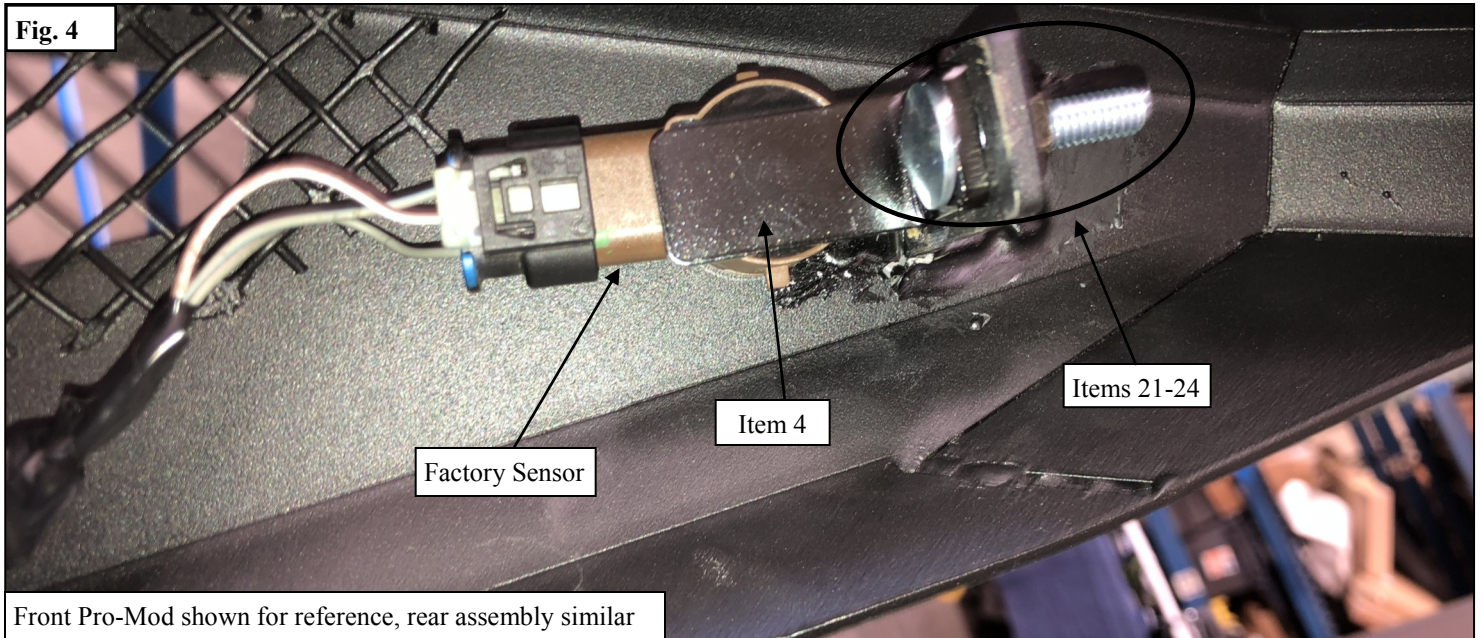

8. Using the supplied M12 hardware, loosely install frame brackets (2) on frame. **Note:** Do not tighten hardware. **See Figure 6.**
9. Using the supplied M12 hardware, loosely install bumper brackets on to the bumper. Then loosely assemble the bumper to the frame brackets. **See Figure 7.**

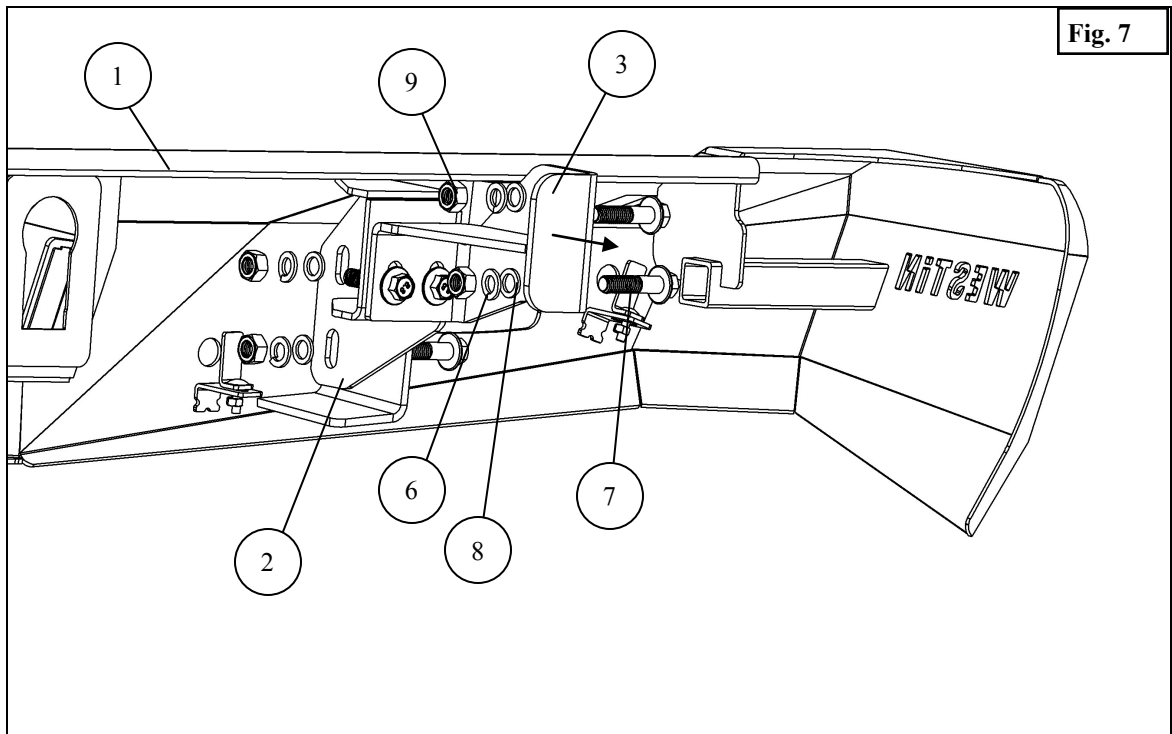
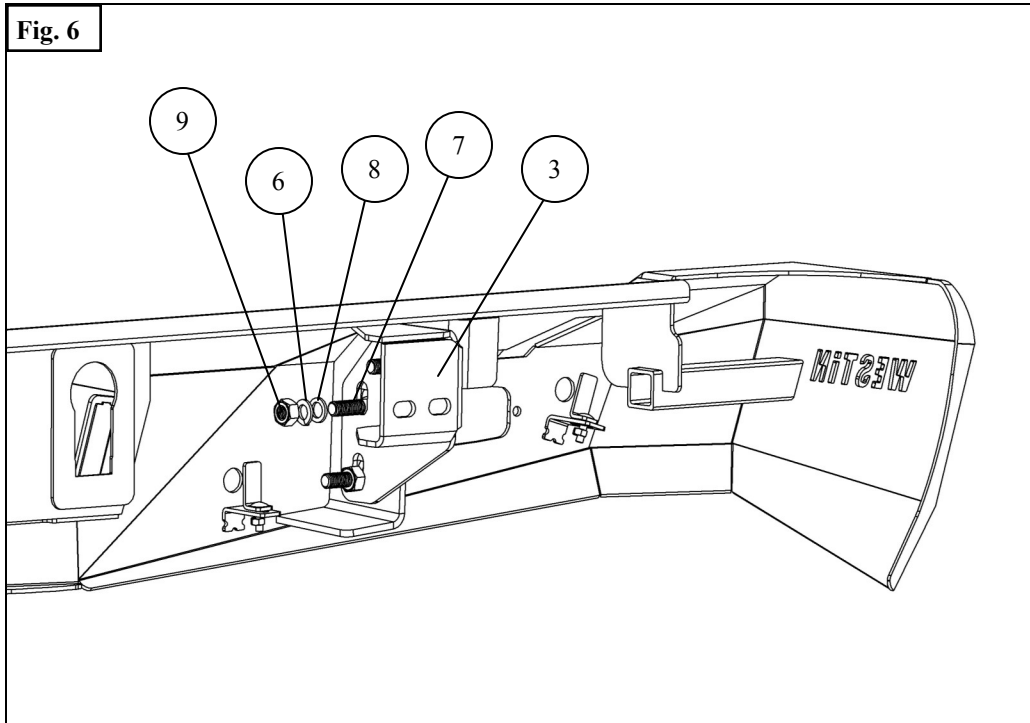

9. Install the Trailer plug and license plate at this time.

WARNING .

After you have mounted bumper on main brackets. CAREFULLY open tailgate. While tailgate is open, adjust the height of the bumper so that it has about 3/8" of clearance with respect to the tailgate. Torque to 50-55 ft-lbs.

INSTALLATION COMPLETE



CARE INSTRUCTIONS

- REGULAR WAXING IS RECOMMENDED. DO NOT USE ANY TYPE OF POLISH OR WAX THAT MAY CONTAIN ABRASIVES.
- STAINLESS STEEL PRODUCTS CAN BE CLEANED WITH MILD SOAP AND WATER. STAINLESS STEEL POLISH SHOULD BE USED TO POLISH SMALL SCRATCHES.
- GLOSS BLACK FINISHES SHOULD BE CLEANED WITH MILD SOAP AND WATER.

WESTIN Westin Automotive Products, Inc.
320 W. Covina Blvd
San Dimas, Ca. 91773

Thank you for choosing Westin products
for additional installation assistance please call
Customer Service (800) 793-7846
www.westinautomotive.com



WARNING



Failure to follow these instructions could lead to death, personal injury, and / or property damage.

Failure to follow these instructions could lead to death, personal injury, and / or property damage.

FASTENERS:

All Westin supplied fasteners must be utilized and installed in accordance with the installation instructions and apply torque to the specifications as defined. **DOUBLE CHECK ALL FASTENERS BEFORE INITIAL USE, AND PERIODICALLY IN THE FUTURE TO ENSURE PROPER FUNCTION AND SAFETY.**

DRILLING:

Most Westin products do not require drilling for installation. If drilling is defined as required, use caution when drilling a vehicle. **FAILURE TO REVIEW AN AREA TO BE DRILLED MAY RESULT IN PERSONAL INJURY AND/OR INJURY TO OTHERS AS WELL AS VEHICLE DAMAGE.**

EYE PROTECTION:

ALWAYS WEAR SAFETY GLASSES OR GOGGLES DURING THE INSTALLATION PROCESS TO AVOID PERSONAL INJURY.

MAXIMUM TOWING/CARRYING CAPACITY: (if applicable)

The Westin Receiver Hitches will have a visible tow rating label affixed directly on the product. User should never exceed the vehicle manufacturers maximum tow and weight rating regardless of the capacity of the hitch. **FAILURE TO FOLLOW THESE GUIDELINES WILL VOID THE WESTIN WARRANTY AND MAY RESULT IN PERSONAL INJURY AND/OR INJURY TO OTHERS AS WELL AS VEHICLE DAMAGE.**

FOR CALIFORNIA RESIDENTS ONLY-PROP 65 WARNING:

Some products may contain chemicals such as DEHP, which can cause cancer, birth defects or other reproductive harm. For more info go to www.p65warnings.ca.gov



Westin Automotive Products, Inc.
320 W. Covina Blvd
San Dimas, Ca. 91773