

## 2024/TOYOTA TACOMA

### STEALTH REAR BUMPER

R670081280103



#### **TOOLS REQUIRED**

- (Allen) 5/32, 7/32
- (Wrench) 10mm, 12mm, 7/16, 9/16, 3/4
- (Socket) 10mm, 12mm, 7/16, 9/16, 3/4
- Ratchet
- Flat Head/Fastener Remover
- Needle Nose Pliers
- Grinder
- Razor
- Black Spray Paint

#### **SKILL LEVEL**

-Easy/Intermediate

**\*\*This installation requires 2 people for best results\*\***

#### **TIME REQUIRED**

- 3 hours for OEM Removal/Bumper Install
- 1 Additional Hour to Wire Lights

**\*\*Labor Rates are based on a vehicle with no pre-existing damage. Wiring labor is based on a standard wiring procedure with light switches installed in an easily accessible location. Custom light triggering or switch mounting location will result in a greater labor charge.\*\***

#### **INCLUDED IN KIT**

- |                                     |                              |
|-------------------------------------|------------------------------|
| 8- 1/4-20 X 1 1/4" Button Head Bolt | 4- 1/2-20 X 4" Hex Head Bolt |
| 8- 1/4" Flat Washer                 | 8- 1/2" Flat Washer          |
| 8- 1/4-20" Nylon Lock Nut           | 4- 1/2-20" Metal Lock Nut    |
| 6- 1/4" Spacer                      | 8- 3m Double Sided Tape      |
| 2- 3/8-16 X 1" Hex Head Bolt        |                              |
| 14- 3/8-16 X 1" Button Head Bolt    |                              |
| 16- 3/8" Flat Washer                |                              |
| 16- 3/8-16" Nylon Lock Nut          |                              |

## **WARNINGS/CAUTIONS BEFORE STARTING INSTALLATION**

#### -BEFORE YOU INSTALL THIS KIT-

Read and understand all instructions, warnings, cautions, & notes contained in this installation instruction guide. Consult your vehicle owner's manual for proper disconnection of electrical and lifting of vehicle if required for installation of this product.

This install may require some technical skills and knowledge of basic mechanical work. If you do not feel that you are capable of performing this install please take this product to a trained professional.

After reading this guide please contact us with any questions or concerns before installing product.  
Customer Service (480) 671-0820

Addictive desert designs is *not* responsible for any bodily injury or harm to you or your vehicle as a result of an improper install.

Proper installation of this kit required knowledge of the factory recommended procedures for removal and installation of original equipment components.

We recommend that the factory shop manual and any special tools needed to service your vehicle be on hand during the installation. Installation of this kit without proper knowledge of the factory recommended procedures may affect the performance of these components and the safety of the vehicle.

Inspect all contents of this package to make sure product is not damaged and all installation hardware has been included. If parts are missing from kit, please be prepared to provide the following information:

1. Name of purchase location
2. Bar Code on side of box
3. Date above bar code
4. Date inside box cover

**\*ALWAYS WEAR EYE PROTECTION WHEN OPERATING POWER TOOLS\***

## STEALTH REAR BUMPER 2024/TOYOTA TACOMA

## REMOVAL

### □ STEP 1

Disconnect the main wiring harness located on the driver side.

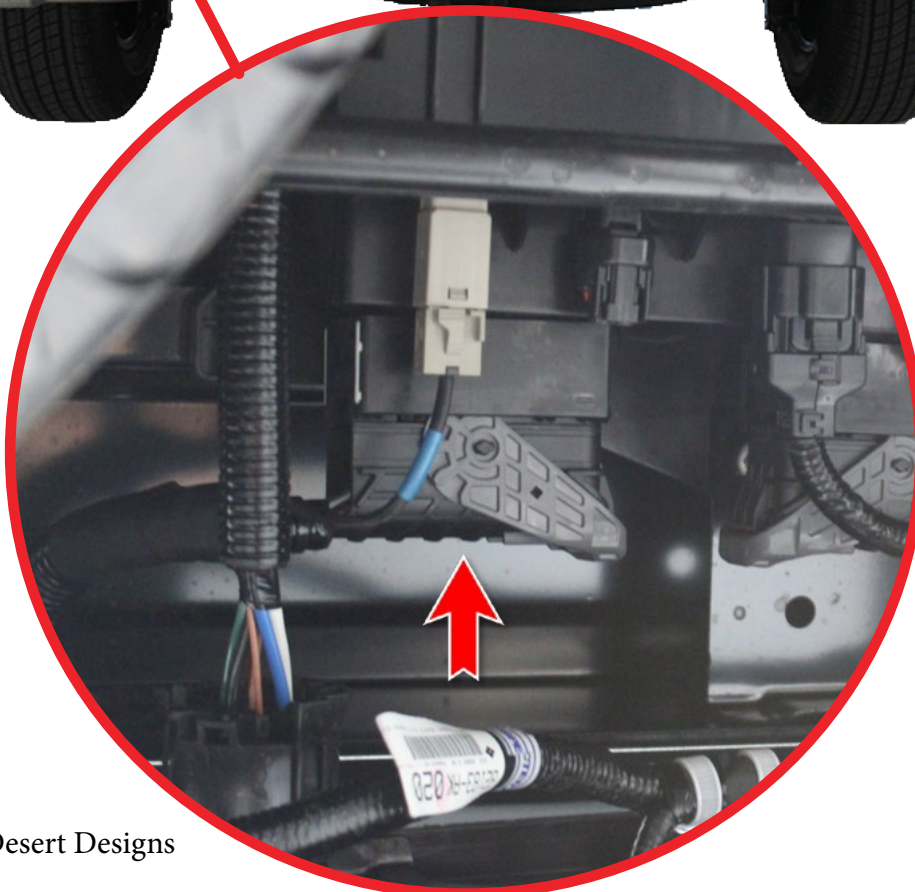

## STEALTH REAR BUMPER 2024/TOYOTA TACOMA

## REMOVAL

### □ STEP 2

Unplug the trailer plug.





## STEALTH REAR BUMPER 2024/TOYOTA TACOMA

## REMOVAL

### □ STEP 3

Using a (12mm socket), remove the side support brackets located on the side of the frame rails.

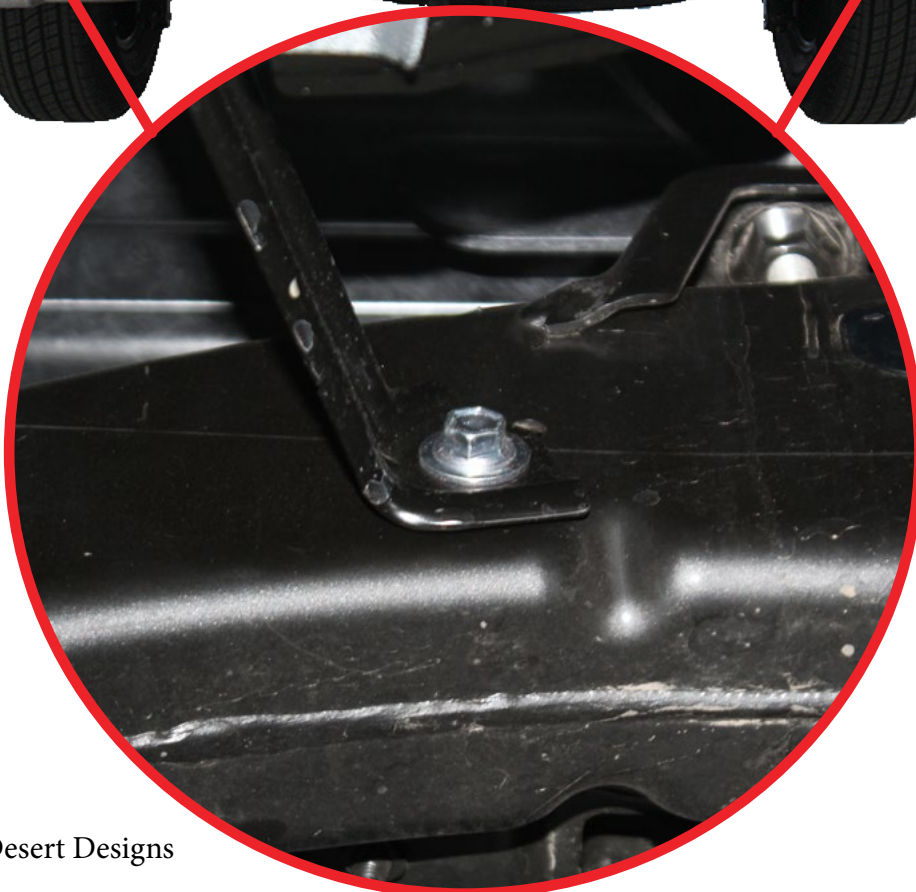

## STEALTH REAR BUMPER 2024/TOYOTA TACOMA

## REMOVAL

### □ STEP 4

Using a (flathead screwdriver), remove the plastic covers located on top of the OEM bumper.





## STEALTH REAR BUMPER 2024/TOYOTA TACOMA

## REMOVAL

### □ STEP 5

Using a (12mm socket), Remove the mounting bolts located underneath the plastic covers removed from step 4.



## STEALTH REAR BUMPER 2024/TOYOTA TACOMA

## REMOVAL

### □ STEP 6

Using a (10mm socket), remove the mounting nuts located in the center. With another person, you can now remove the OEM bumper.





## STEALTH REAR BUMPER 2024/TOYOTA TACOMA

## REMOVAL

### □ STEP 7

Using a (flathead screwdriver), Remove the push pins located on the underneath of the bumper as shown below.

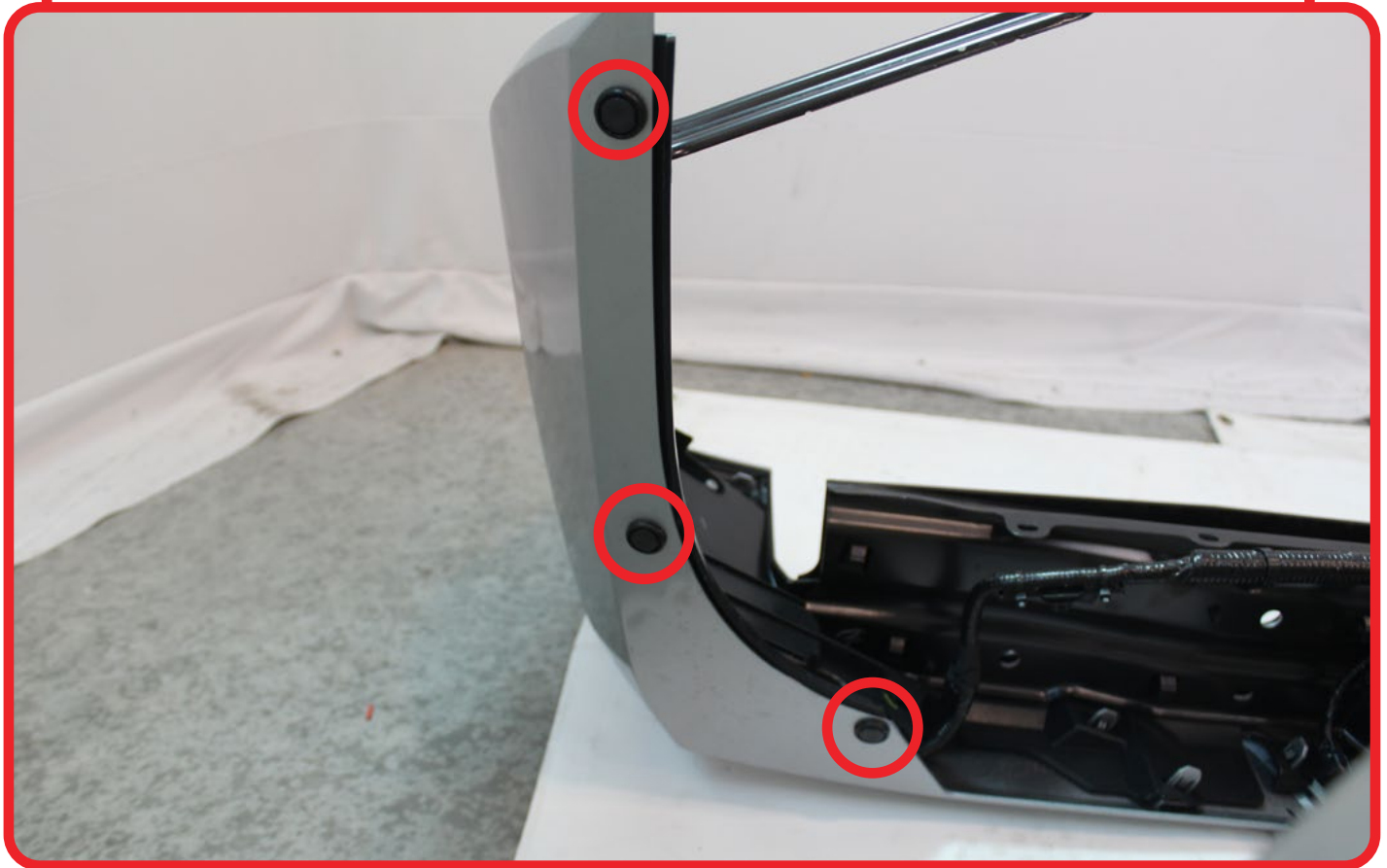
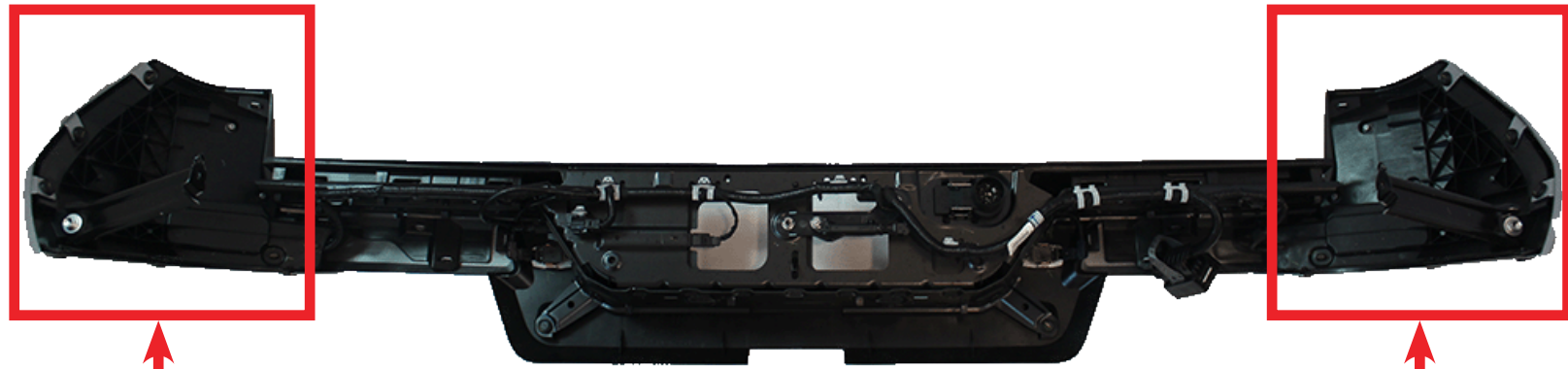



## STEALTH REAR BUMPER 2024/TOYOTA TACOMA

## REMOVAL

### □ STEP 8

Remove the 4x sensors from the bezels by prying the tabs and pulling. **\*\*Pry gently due to breakage\*\***

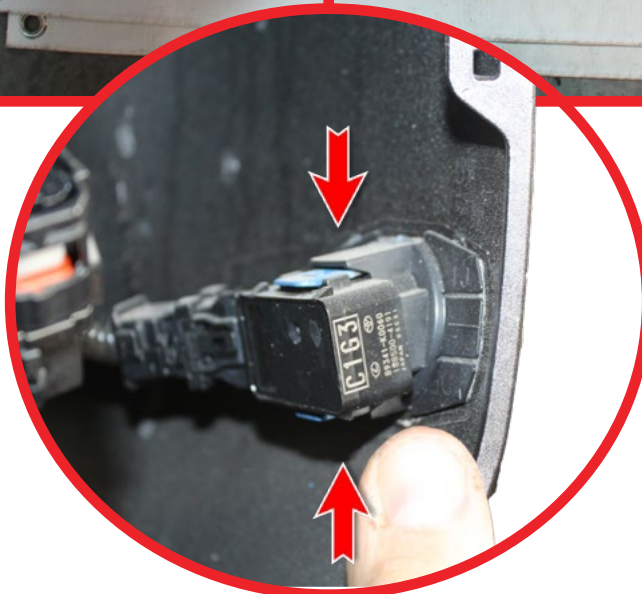
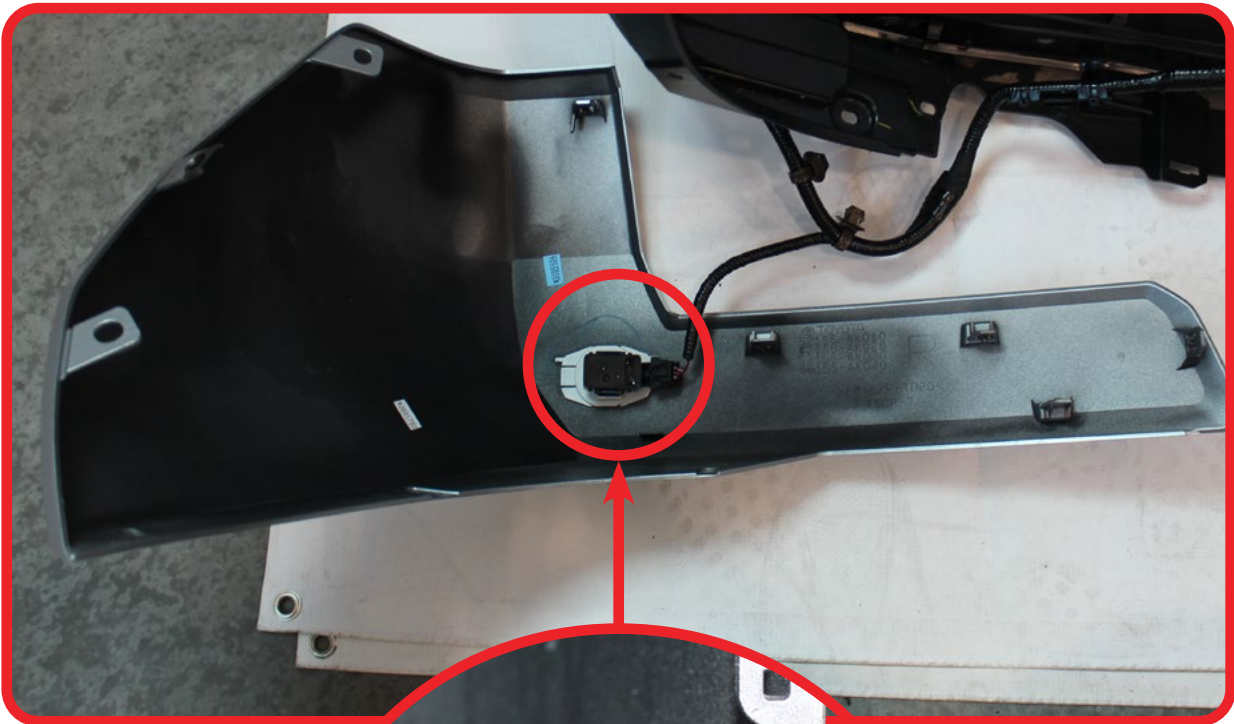

## STEALTH REAR BUMPER 2024/TOYOTA TACOMA

## REMOVAL

### □ STEP 9

Using a (flathead screwdriver), remove the sensors bezels.

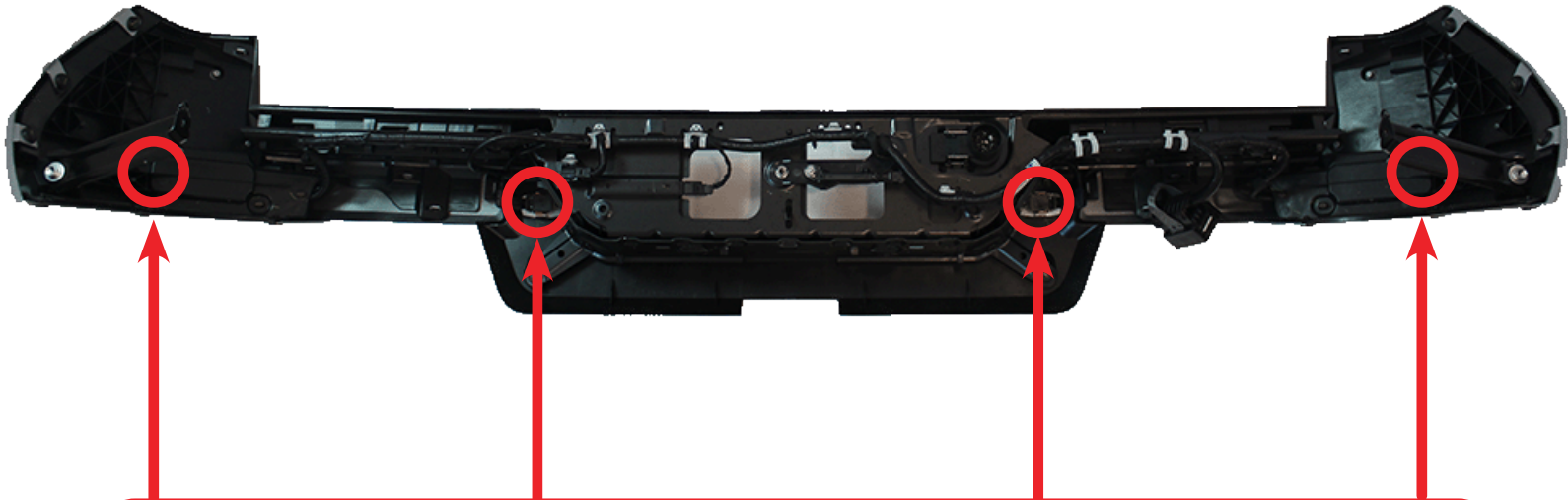



## STEALTH REAR BUMPER 2024/TOYOTA TACOMA

## REMOVAL

### □ STEP 10

Remove all wiring loom clips with (needle nose pliers) from the OEM bumper.

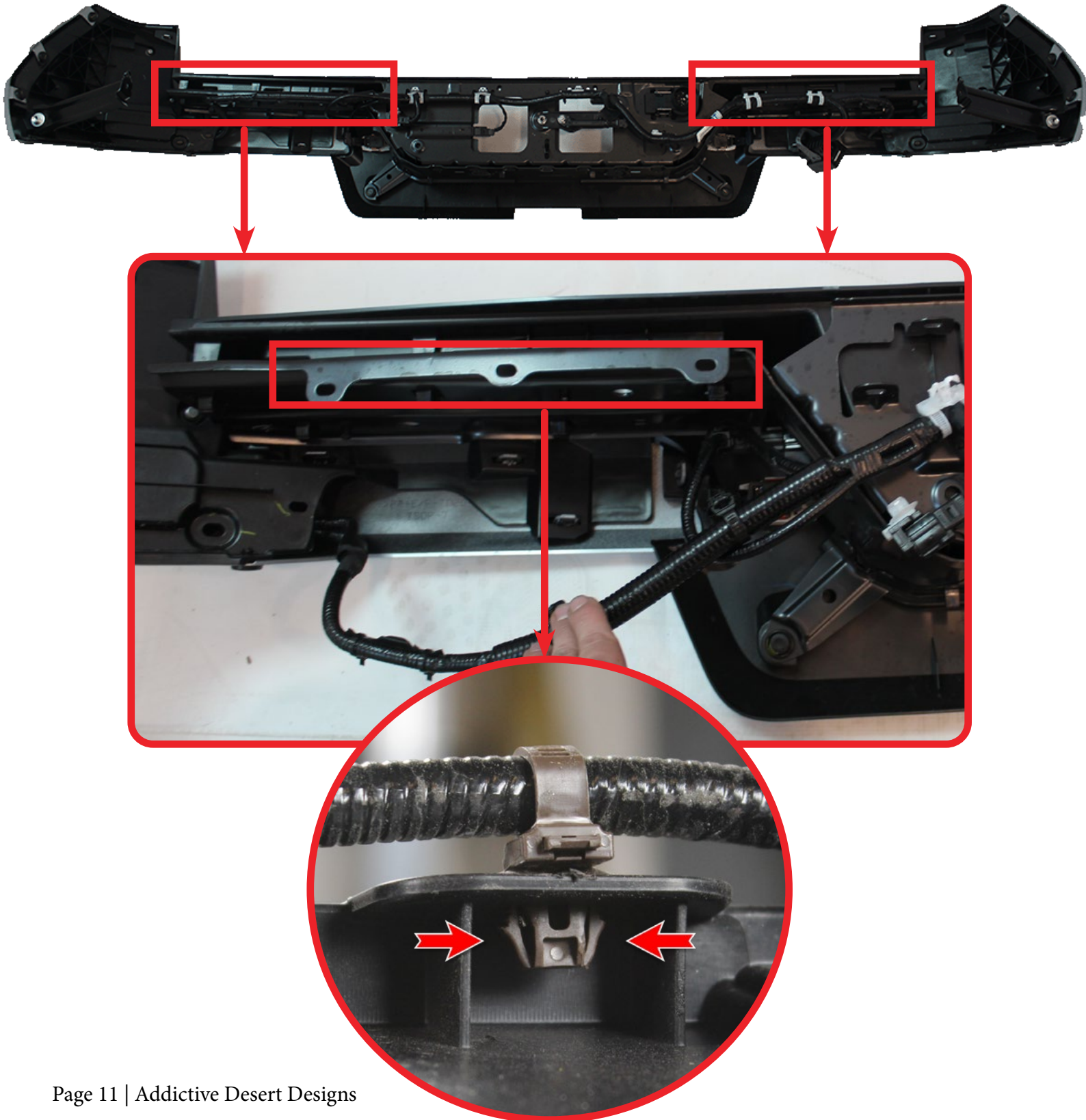

## STEALTH REAR BUMPER 2024/TOYOTA TACOMA

## REMOVAL

### □ STEP 11

Using a (10mm socket) remove the key less entry antenna.

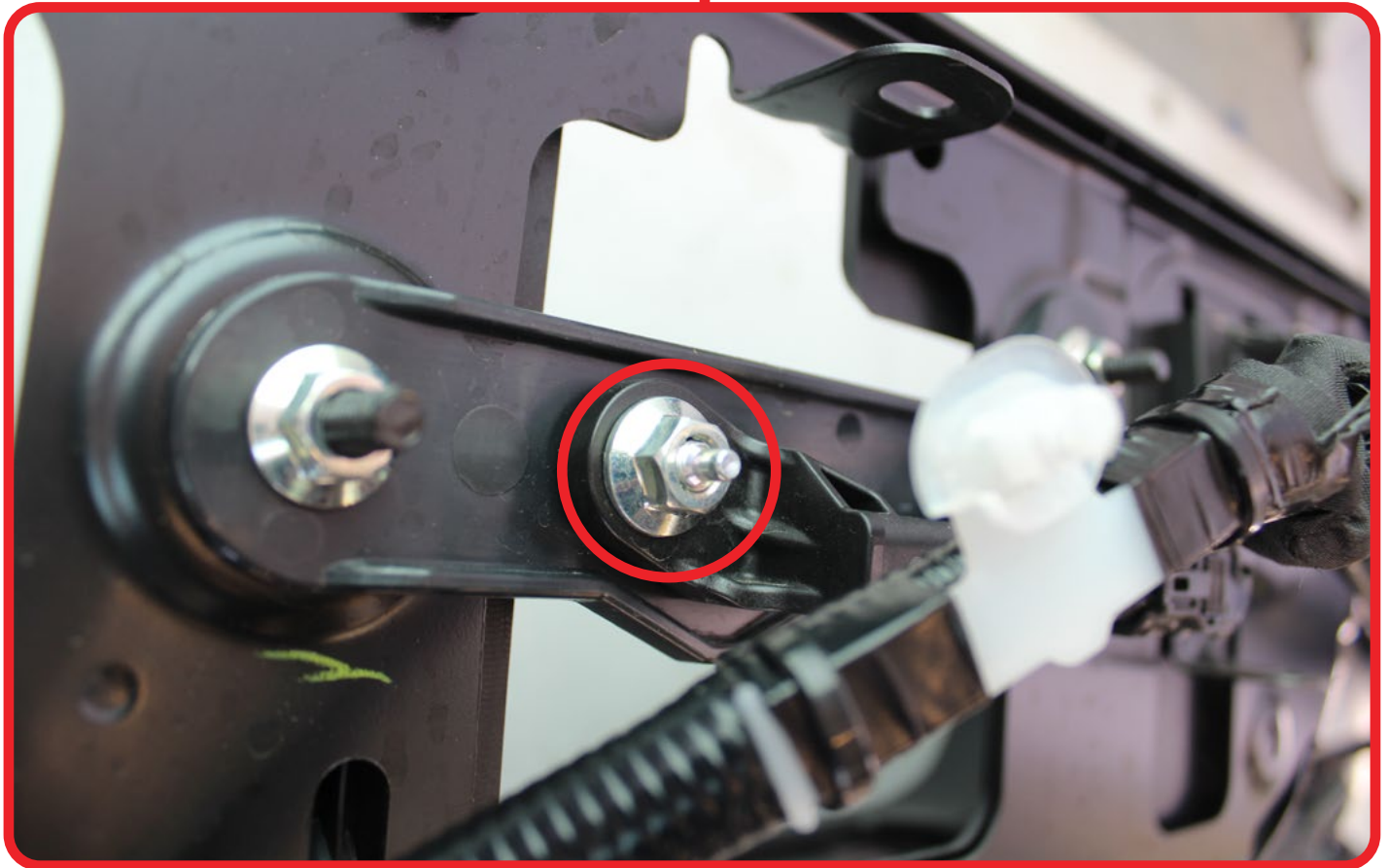
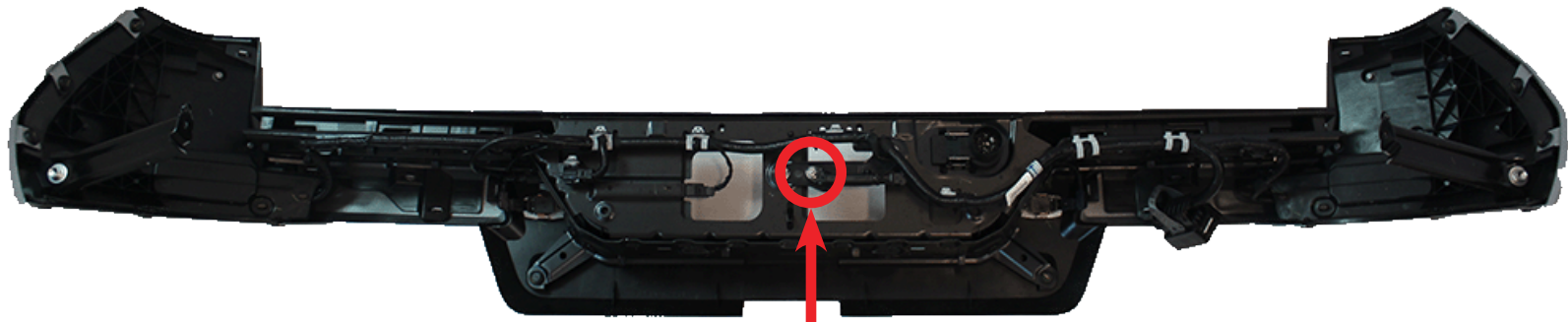



## STEALTH REAR BUMPER 2024/TOYOTA TACOMA

## REMOVAL

### □ STEP 12

Remove the trailer plug on the backside of the bumper using a (flathead screwdriver) to release clips.

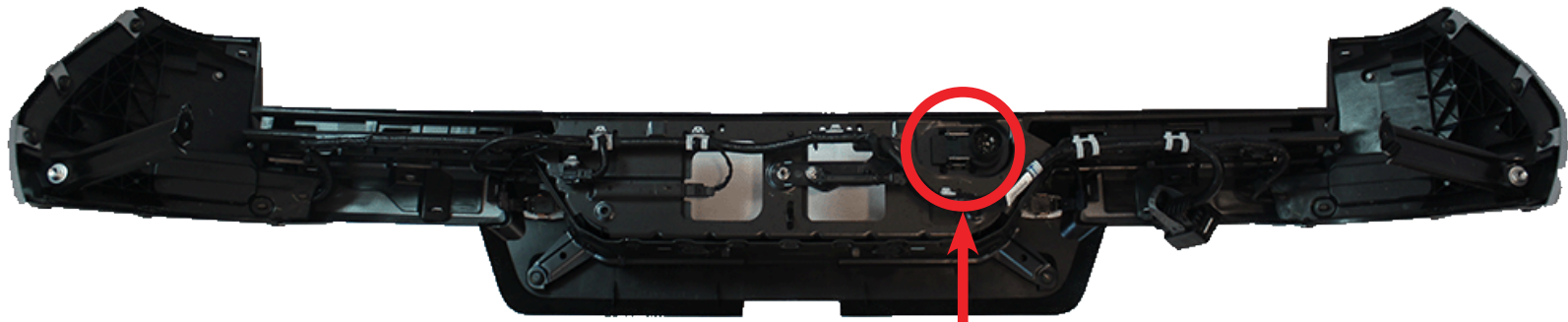

## STEALTH REAR BUMPER 2024/TOYOTA TACOMA

## REMOVAL

### □ STEP 13

Remove the license plate light using a (flathead screwdriver) to release clips as shown below.

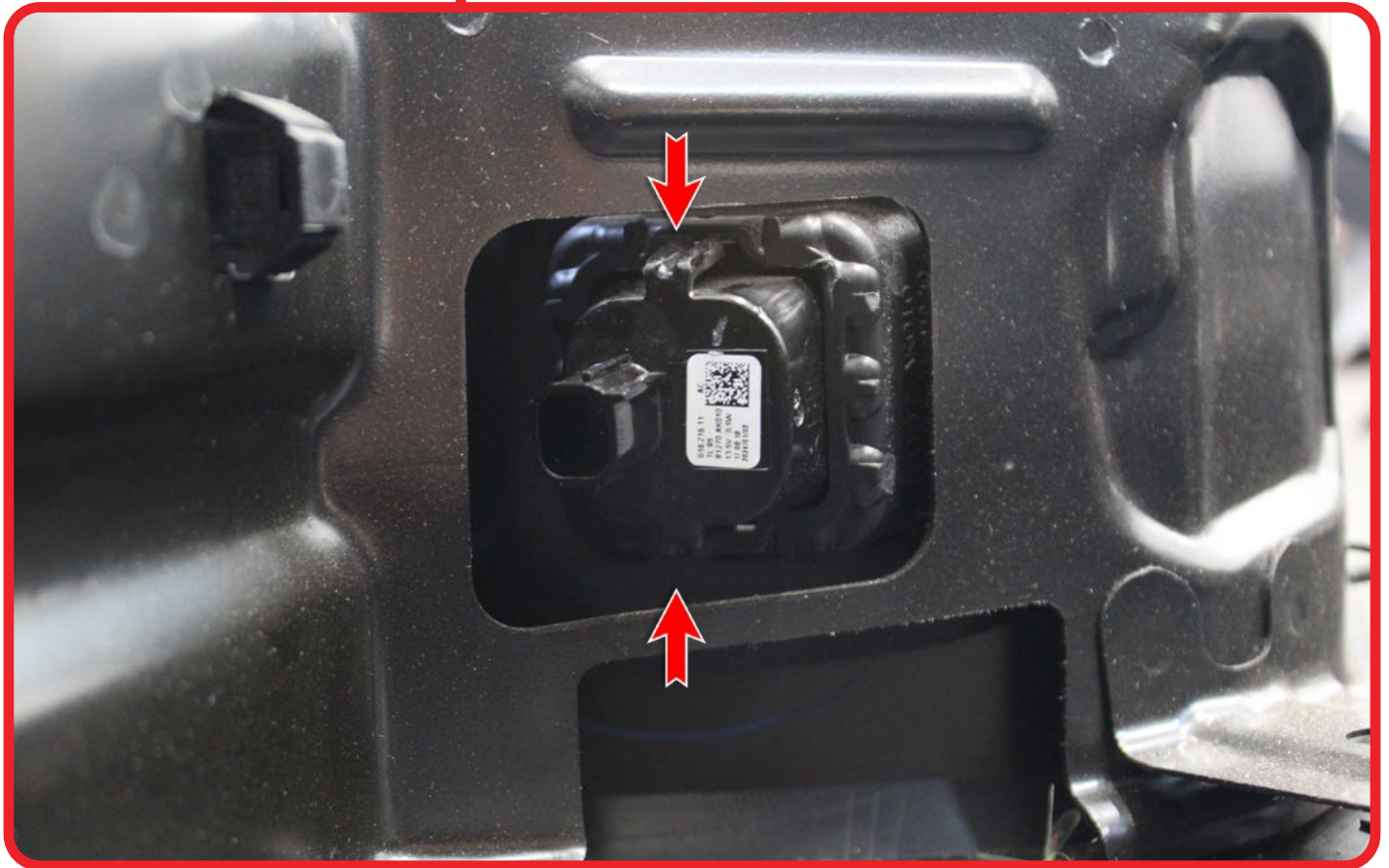



## STEALTH REAR BUMPER 2024/TOYOTA TACOMA

## REMOVAL

### STEP 14

Using a (10mm socket), Remove the 6x blind spot sensor nuts.

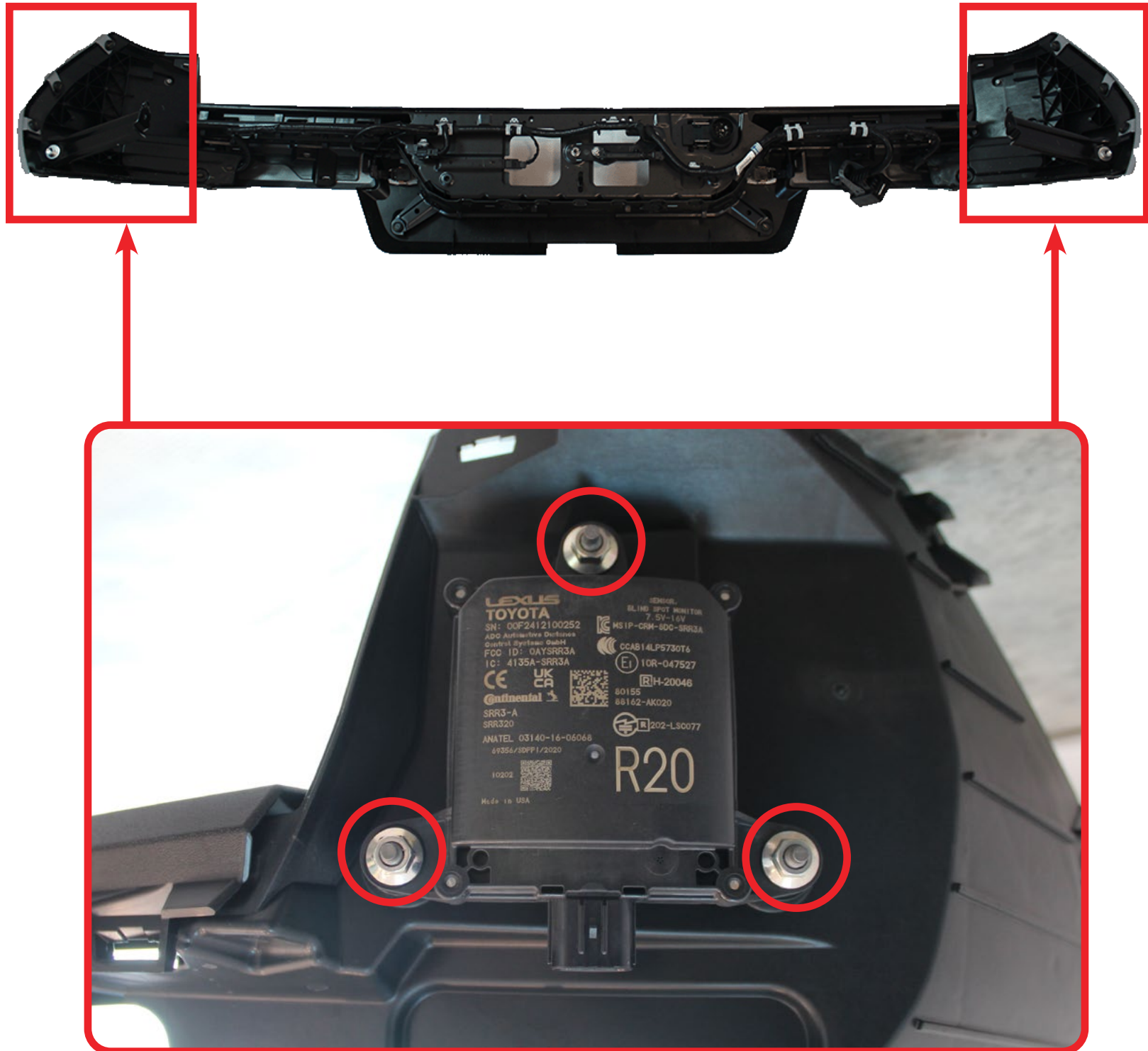

## STEALTH REAR BUMPER 2024/TOYOTA TACOMA

## REMOVAL

### □ STEP 15

Using a (grinder), Grind off the studs located center of the hitch as shown below and apply (black spray paint) to prevent rust.

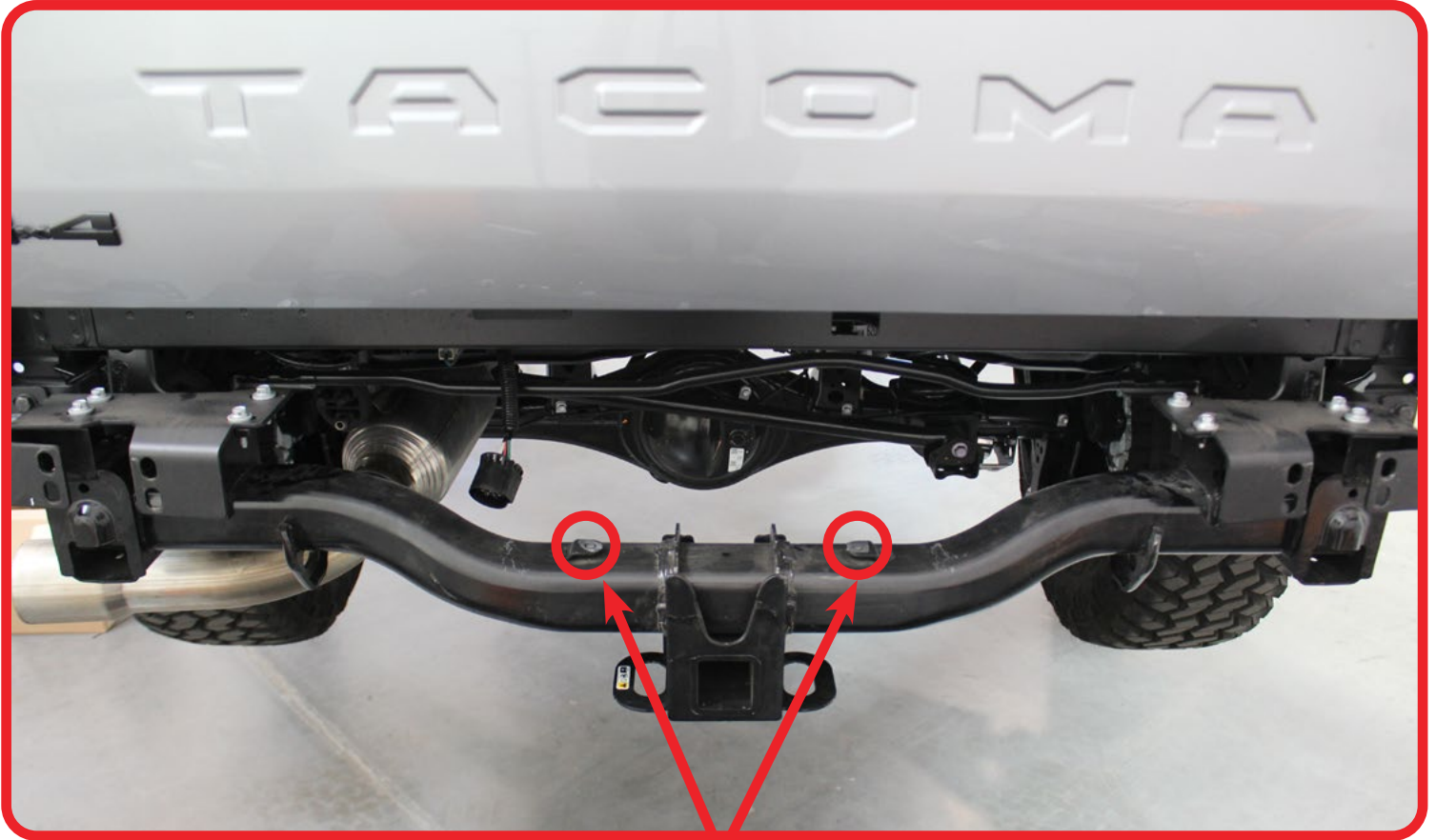



## STEALTH REAR BUMPER 2024/TOYOTA TACOMA

## REMOVAL

### □ STEP 16

Using a (flathead screwdriver), Remove the plastic caps located on the side of the frame rails as shown below.



## STEALTH REAR BUMPER 2024/TOYOTA TACOMA

## INSTALL

### □ STEP 17

Install the mounting brackets using a (12mm Socket) with the OEM hardware removed from steps 3 & 5.

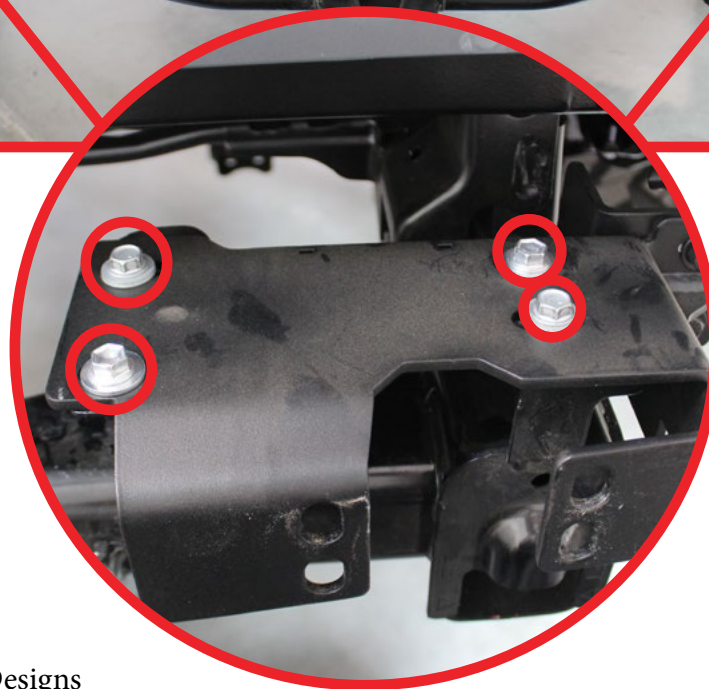
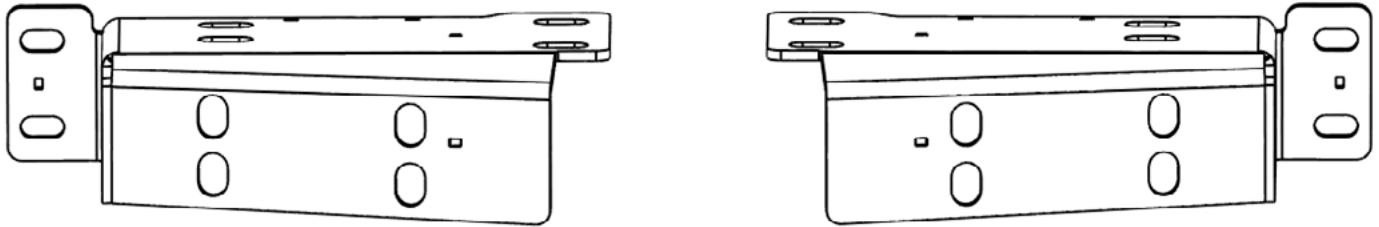



## STEALTH REAR BUMPER 2024/TOYOTA TACOMA

## INSTALL

### □ STEP 18

Install the support brackets as shown below with the provided **(C, D2, D3)** 3/8" hardware using a (9/16 socket) and a (9/16 wrench).

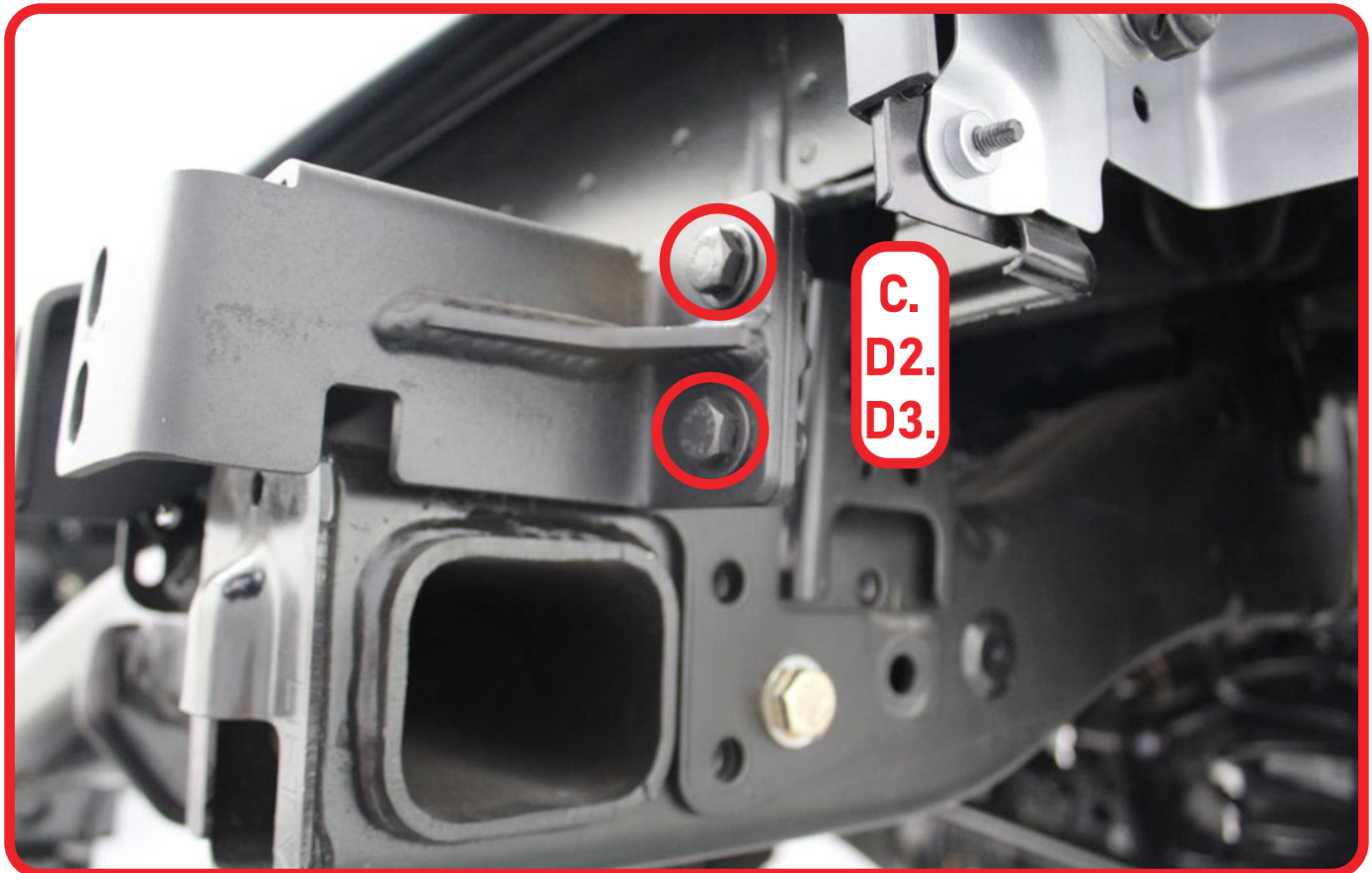
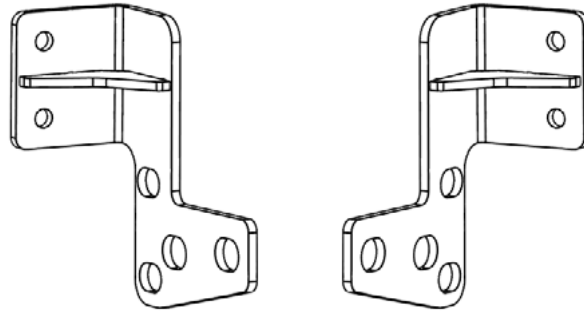

## STEALTH REAR BUMPER 2024/TOYOTA TACOMA

## INSTALL

### □ STEP 19

Using a (3/4 socket) and a (3/4 wrench), install the provided (**E, E1, E2**) 1/2" hardware through the capped holes from **step 16** using the provided backer plate on the inside as shown below. (**Leave the one bolt on each side out for later**)

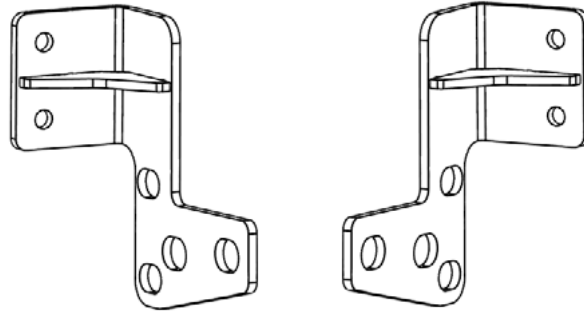



## STEALTH REAR BUMPER 2024/TOYOTA TACOMA

## INSTALL

### □ STEP 20

Remove double sided tape from the bezel until the surface is clear of residue.

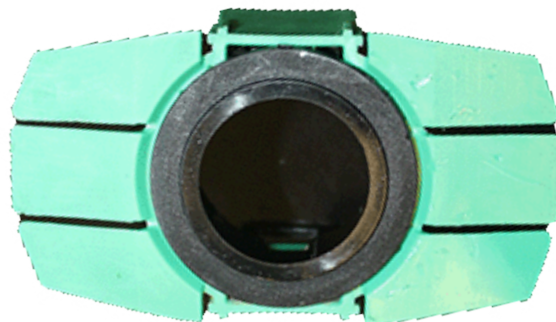

## STEALTH REAR BUMPER 2024/TOYOTA TACOMA

## INSTALL

### □ STEP 21

Install the provided 3m double sided tape to each side of the bezel wings and trim excess with a (razor blade).

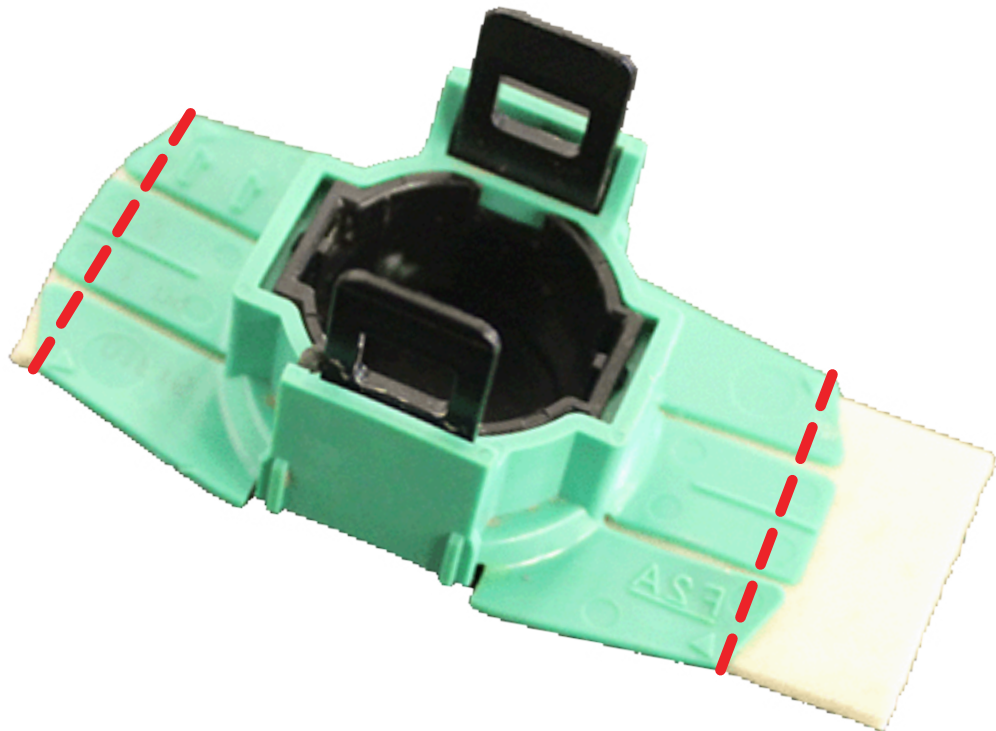
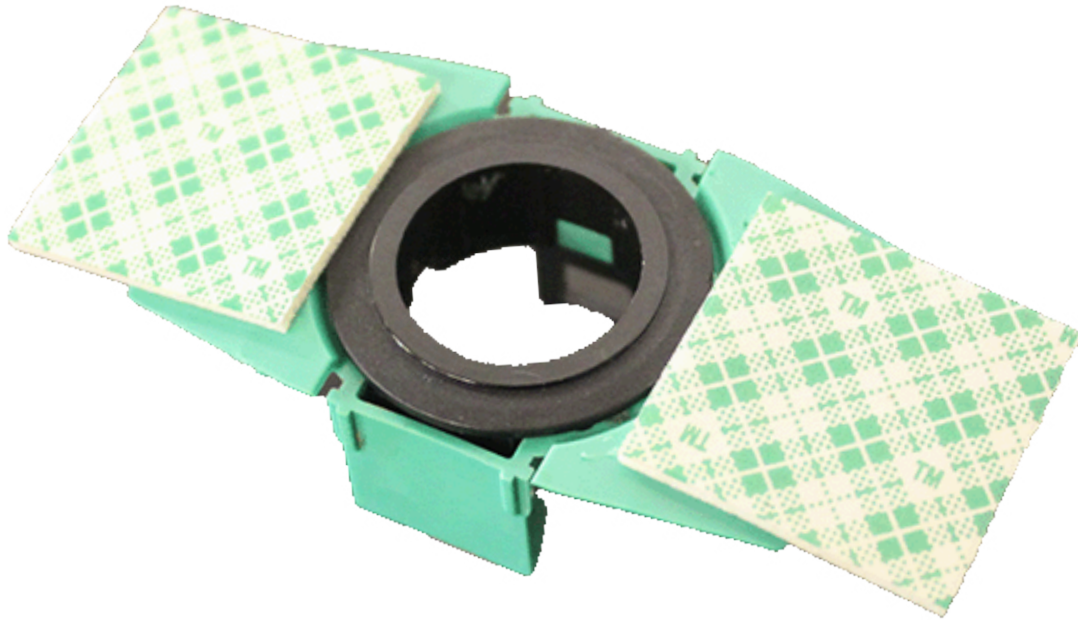

## STEALTH REAR BUMPER 2024/TOYOTA TACOMA

## INSTALL

### □ STEP 22

Install the sensor bezels in the orientation shown below.





## STEALTH REAR BUMPER 2024/TOYOTA TACOMA

## INSTALL

### □ STEP 23

**(Optional)** Using (black spray paint), lightly paint over the sensor before installing.



## STEALTH REAR BUMPER 2024/TOYOTA TACOMA

## INSTALL

### □ STEP 24

Using a (5/32 allen) and a (7/16 wrench), Install the blind spot sensors as shown below with the provided **(A, A1, A2)** 1/4" hardware and the **(B)** spacers between the bumper and the sensor.



**A.**  
**A1.**  
**A2.**  
**B.**

## STEALTH REAR BUMPER 2024/TOYOTA TACOMA

## INSTALL

### □ STEP 25

Using a (flathead screwdriver), Install the trailer plug by prying out the tabs as shown below.

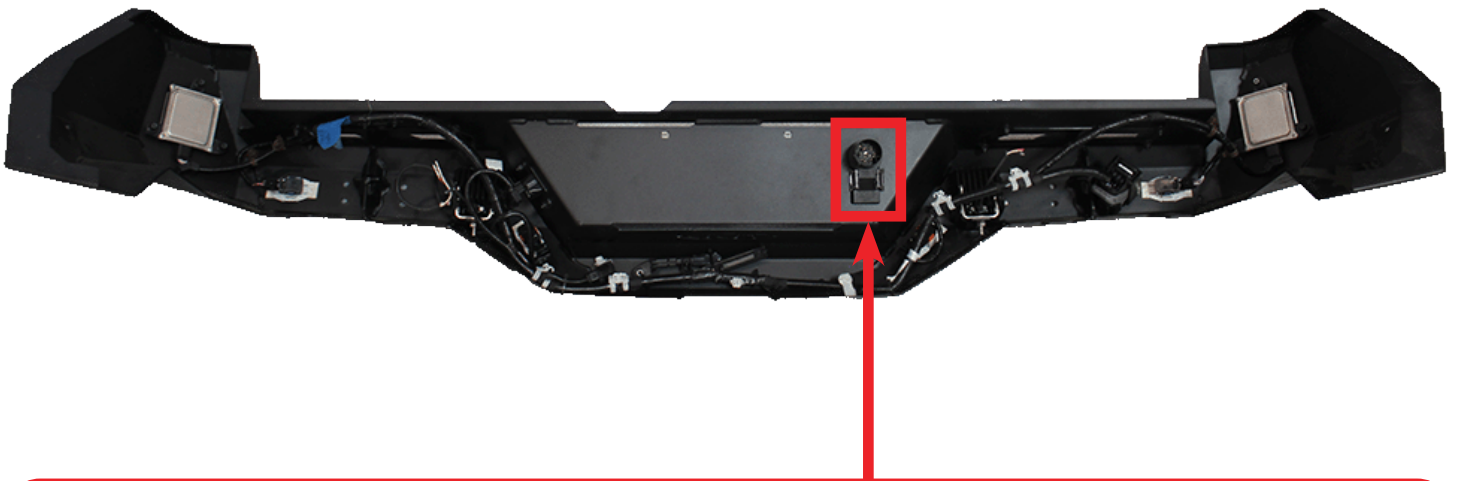





## STEALTH REAR BUMPER 2024/TOYOTA TACOMA

## INSTALL

### □ STEP 27

With the help from another installer, install the bumper using a (7/32 allen) and a (9/16 wrench) with the provided **(D, D1, D2)** 3/8" hardware.



## STEALTH REAR BUMPER 2024/TOYOTA TACOMA

## INSTALL

### □ STEP 28

Using a (9/16 socket) and a (9/16 wrench), assemble the side support brackets with the provided (C, D2, D3) 3/8" hardware as shown below. **\*\*Keep loose for adjustments\*\***

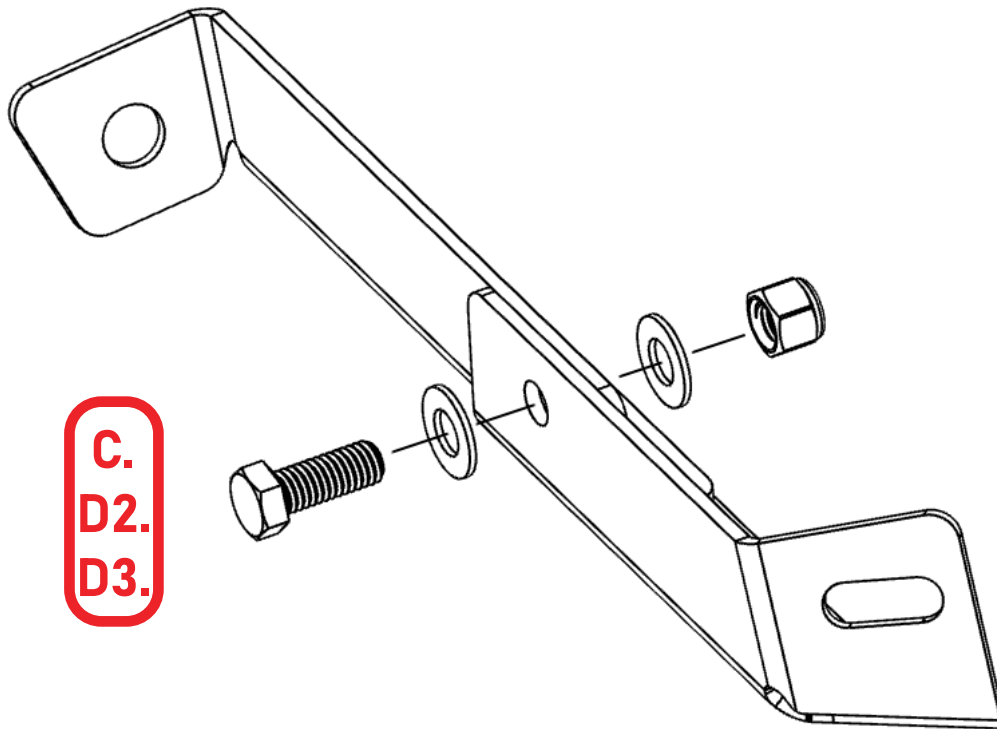



## STEALTH REAR BUMPER 2024/TOYOTA TACOMA

## INSTALL

### □ STEP 29

Install the side support brackets using a (3/4 Socket) and a (3/4 wrench) in the mounting holes from step 19 shown in **fig 1** with the provided **(E, E1, E2)** 1/2" hardware. Install the provided **(D1, D2 D3)** 3/8" hardware with a (7/32 allen) and a (9/16 wrench) as shown in **fig. 2**.

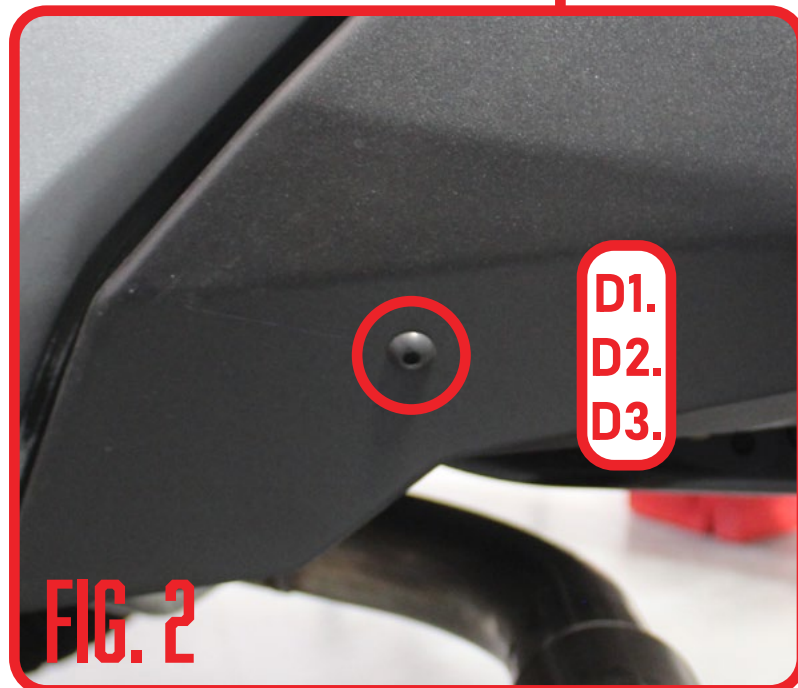
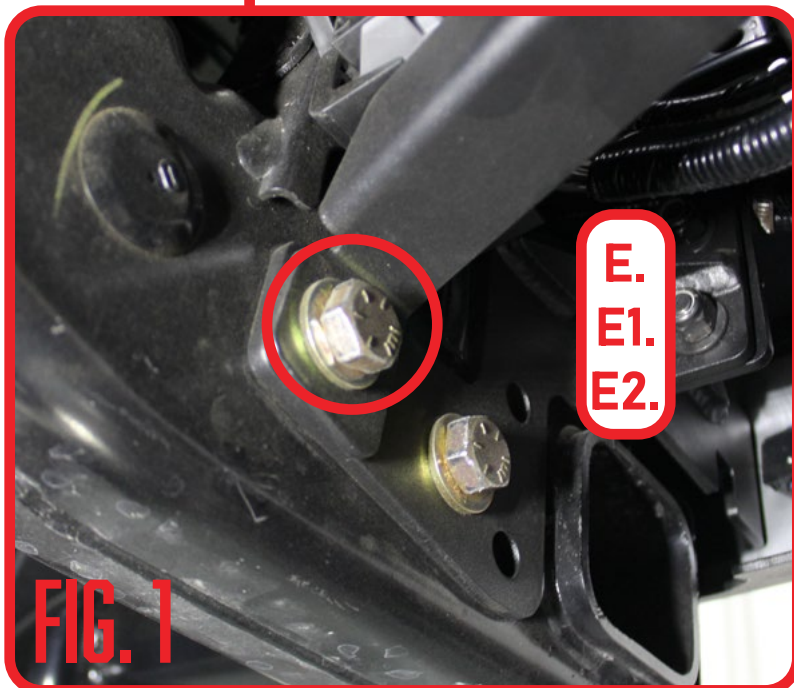

## STEALTH REAR BUMPER 2024/TOYOTA TACOMA

## INSTALL

### □ STEP 30

Plug in the main wiring harness.

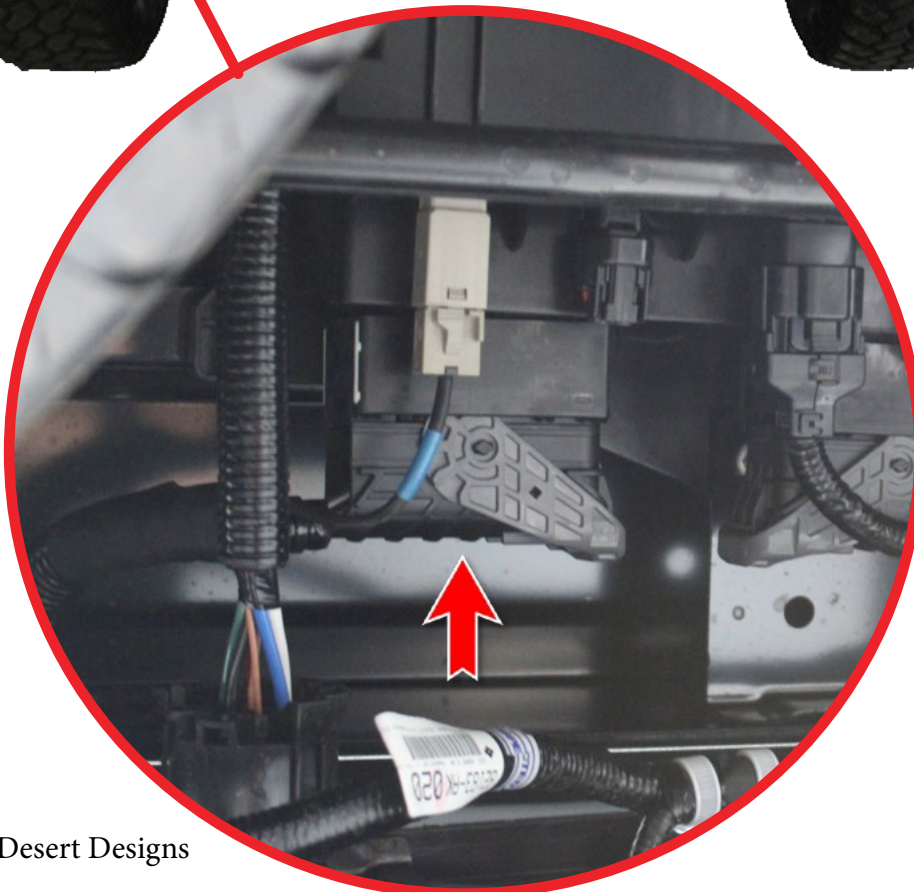



## STEALTH REAR BUMPER 2024/TOYOTA TACOMA

## INSTALL

### □ STEP 31

Plug in the trailer plug.





## STEALTH REAR BUMPER 2024/TOYOTA TACOMA

## FINAL

### STEP 32

Stand back and enjoy your new ADD Stealth Rear Bumper.

Check and re-tighten, if needed, all mounting bolts after 100 miles and periodically thereafter.



THIS PRODUCT IS PROTECTED BY ONE OR MORE U.S. PATENTS  
[WWW.ADDICTIVEDESERTDESIGNS.COM/PATENTS](http://WWW.ADDICTIVEDESERTDESIGNS.COM/PATENTS)

FOR ADDITIONAL SUPPORT OR TECHNICAL QUESTIONS,  
PLEASE CALL 480-671-0820 OR  
EMAIL [INFO@ADDICTIVEDESERTDESIGNS.COM](mailto:INFO@ADDICTIVEDESERTDESIGNS.COM)