



INSTALLATION GUIDE

24/FORD RANGER RAPTOR

PHANTOM FRONT BUMPER

F720265070103



TOOLS REQUIRED

(Torx) T20

(Allen) 5/32, 7/32

(Wrench) 8mm, 10mm, 12mm, 15mm, 5/16, 7/16, 9/16

(Socket) 8mm, 10mm, 12mm, 15mm, 5/16, 7/16, 9/16

Ratchet

Flat Head/Fastener Remover

Razor Blade

Grinder/Cutoff Wheel



TIME REQUIRED

- 4 hours for OEM Removal/Bumper Install

-1 Additional Hour to Wire Lights

****Labor Rates are based on a vehicle with no pre-existing damage. Wiring labor is based on a standard wiring procedure with light switches installed in an easily accessible location. Custom light triggering or switch mounting location will result in a greater labor charge.****



SKILL LEVEL

-Medium/Mechanical Knowledge

****This installation requires 2 people for best results****

⚠️ WARNINGS/CAUTIONS BEFORE STARTING INSTALLATION ⚠️

-BEFORE YOU INSTALL THIS KIT-

➔ **Read and understand all instructions,** ➔

warnings, cautions, & notes contained in this installation instruction guide. Consult your vehicle owner's manual for proper disconnection of electrical and lifting of vehicle if required for installation of this product.

This install may require some technical skills and knowledge of basic mechanical work. If you do not feel that you are capable of performing this install please take this product to a trained professional.

After reading this guide please contact us with any questions or concerns before installing product.

Customer Service (480) 671-0820

Addictive desert designs is not responsible for any bodily injury or harm to you or your vehicle as a result of an improper install.

Proper installation of this kit required knowledge of the factory recommended procedures for removal and installation of original equipment components.

We recommend that the factory shop manual and any special tools needed to service your vehicle be on hand during the installation. Installation of this kit without proper knowledge of the factory recommended procedures may affect the performance of these

components and the safety of the vehicle. Inspect all contents of this package to make sure product is not damaged and all installation hardware has been included. If parts are missing from kit, please be prepared to provide the following information:

1. Name of purchase location
2. Bar Code on side of box
3. Date above bar code
4. Date inside box cover

ALWAYS WEAR EYE PROTECTION WHEN OPERATING POWER TOOLS



INSTALLATION GUIDE

HARDWARE/PARTS

A.

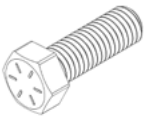

3/8-16 X 1" HEX HEAD BOLT GRADE 8

QTY: 6

A1.



3/8" FENDER WASHER

QTY: 8

A2.

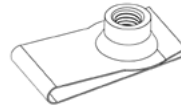

3/8-16 U-NUT

QTY: 6

B.



3/8-16 X 1" BUTTON HEAD BOLT BLACK

QTY: 5

B1.



3/8-16 NYLON LOCK NUT BLACK

QTY: 7

B2.



3/8 FLAT WASHER BLACK

QTY: 9

C.



3/8-16 X 1" CARRIAGE BOLT

QTY: 2

D.



1/4-20 NYLON LOCK NUT

QTY: 6

D1.



1/4" FLAT WASHER

QTY: 6

D2.



1/4-20 X 3/4" BUTTON HEAD BOLT BLACK

QTY: 6

F.

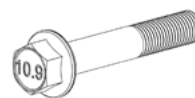

M10-1.5 X 60MM HEX BOLT

QTY: 2

G.



3M DOUBLE SIDED 1X1 SQUARE

QTY: 4

Reference this page throughout the install



INSTALLATION GUIDE

PHANTOM FRONT BUMPER 24/FORD RANGER RAPTOR

REMOVAL

□ STEP 1

Using a (15mm socket) remove the skid plate. ****Keep hardware for re-use****

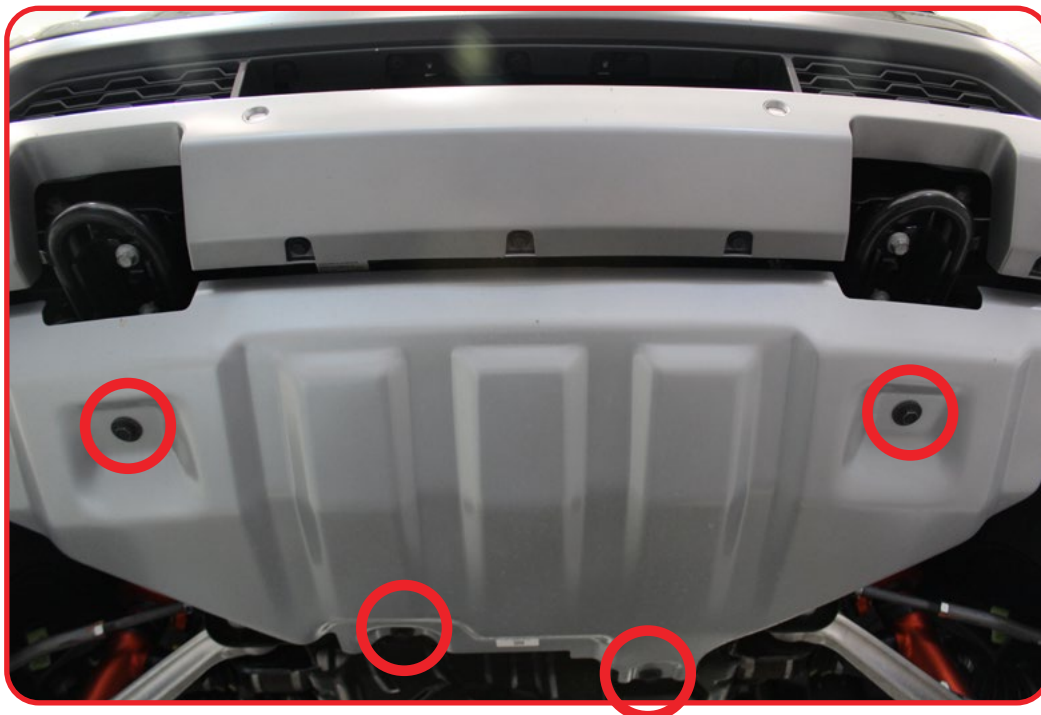



INSTALLATION GUIDE

PHANTOM FRONT BUMPER 24/FORD RANGER RAPTOR

REMOVAL

□ STEP 2

Using a (12mm socket) remove the hardware circled below.

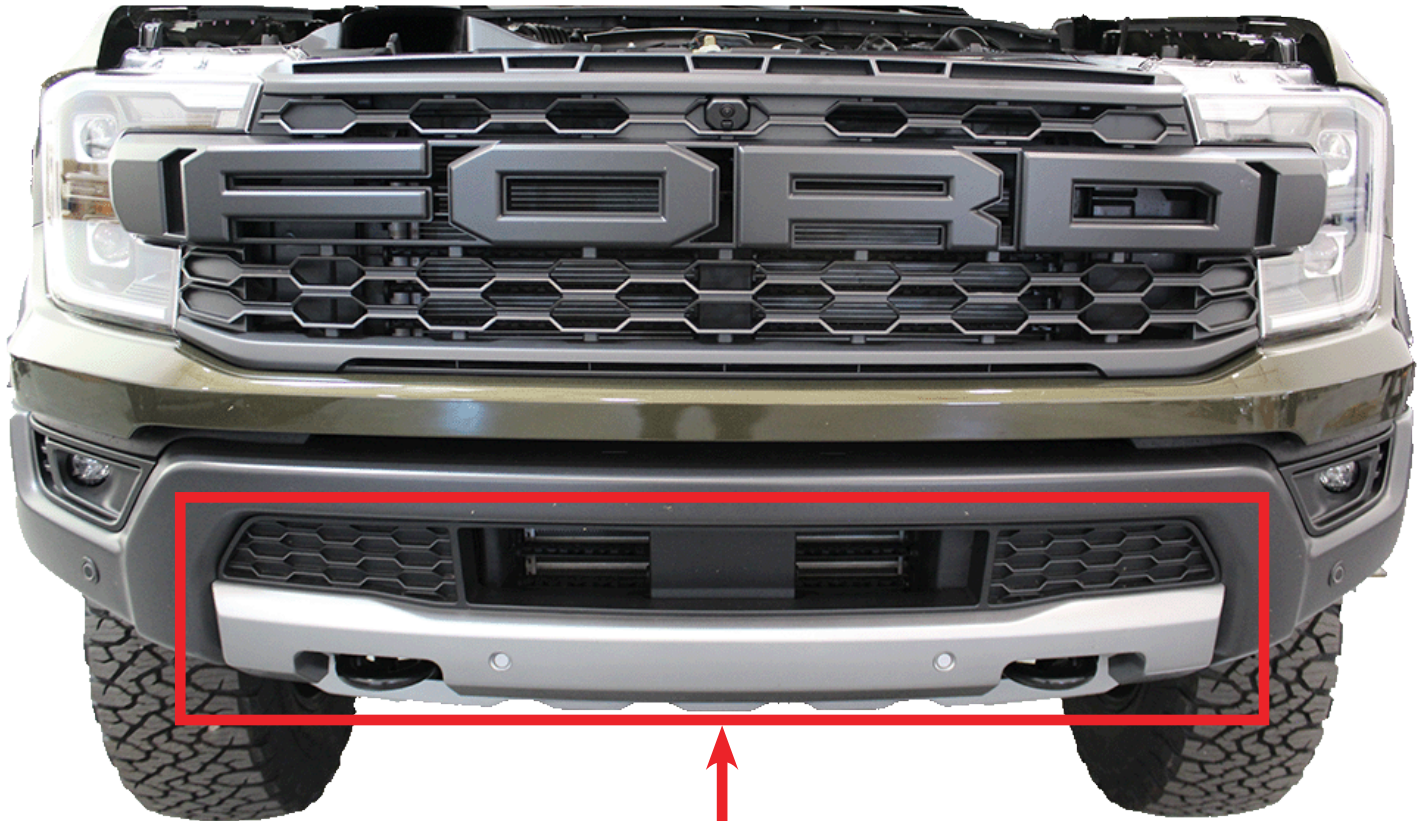



INSTALLATION **GUIDE**

PHANTOM FRONT BUMPER 24/FORD RANGER RAPTOR

REMOVAL

STEP 3

Pull the cover off away from the bumper.





INSTALLATION **GUIDE**

PHANTOM FRONT BUMPER 24/FORD RANGER RAPTOR

REMOVAL

□ STEP 4

Holding the cover in one hand unplug the sensor harness located on the driver side highlighted below.

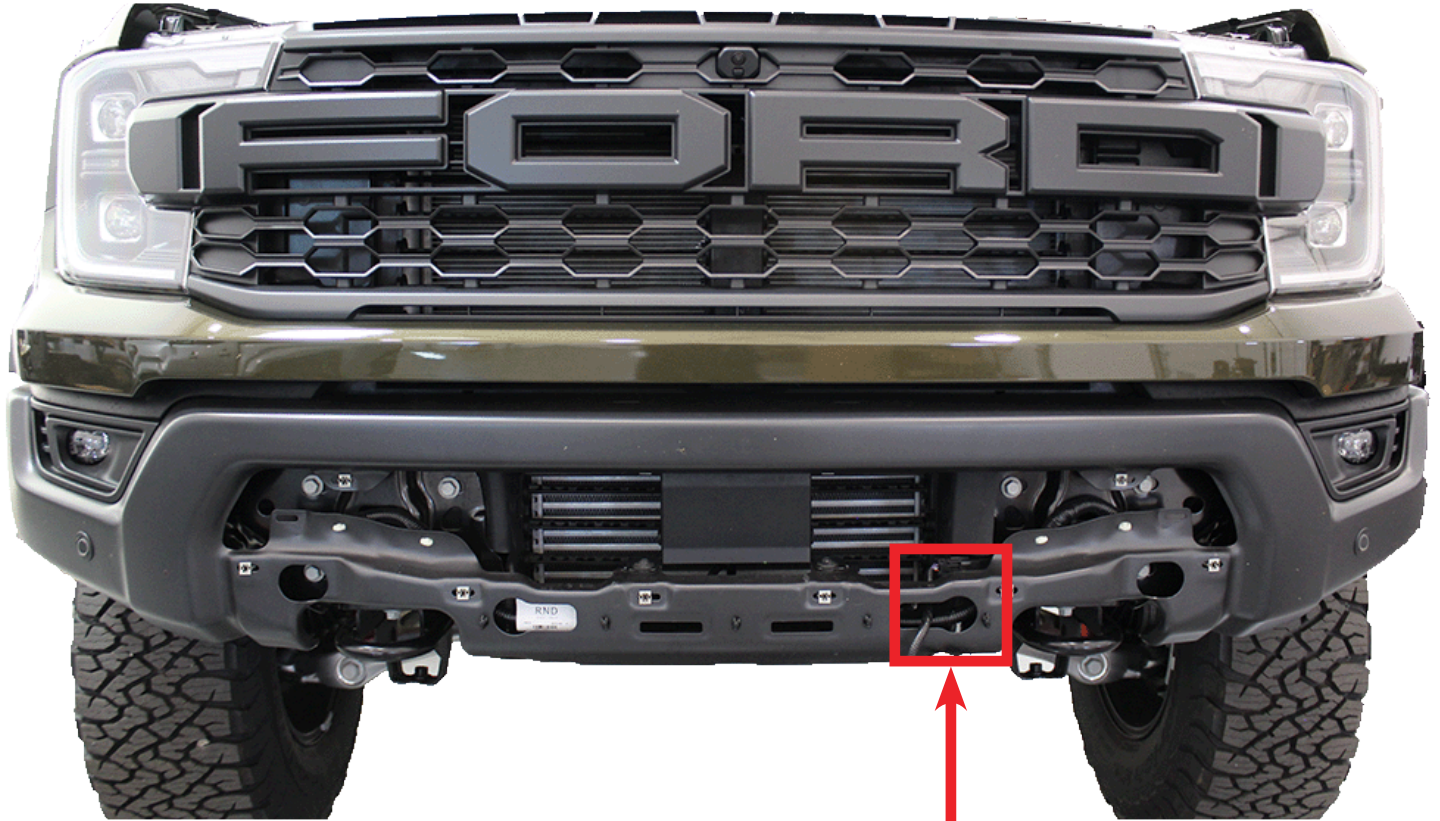



INSTALLATION GUIDE

PHANTOM FRONT BUMPER 24/FORD RANGER RAPTOR

REMOVAL

□ STEP 5

Using a (flat head screwdriver) remove the valence cover.

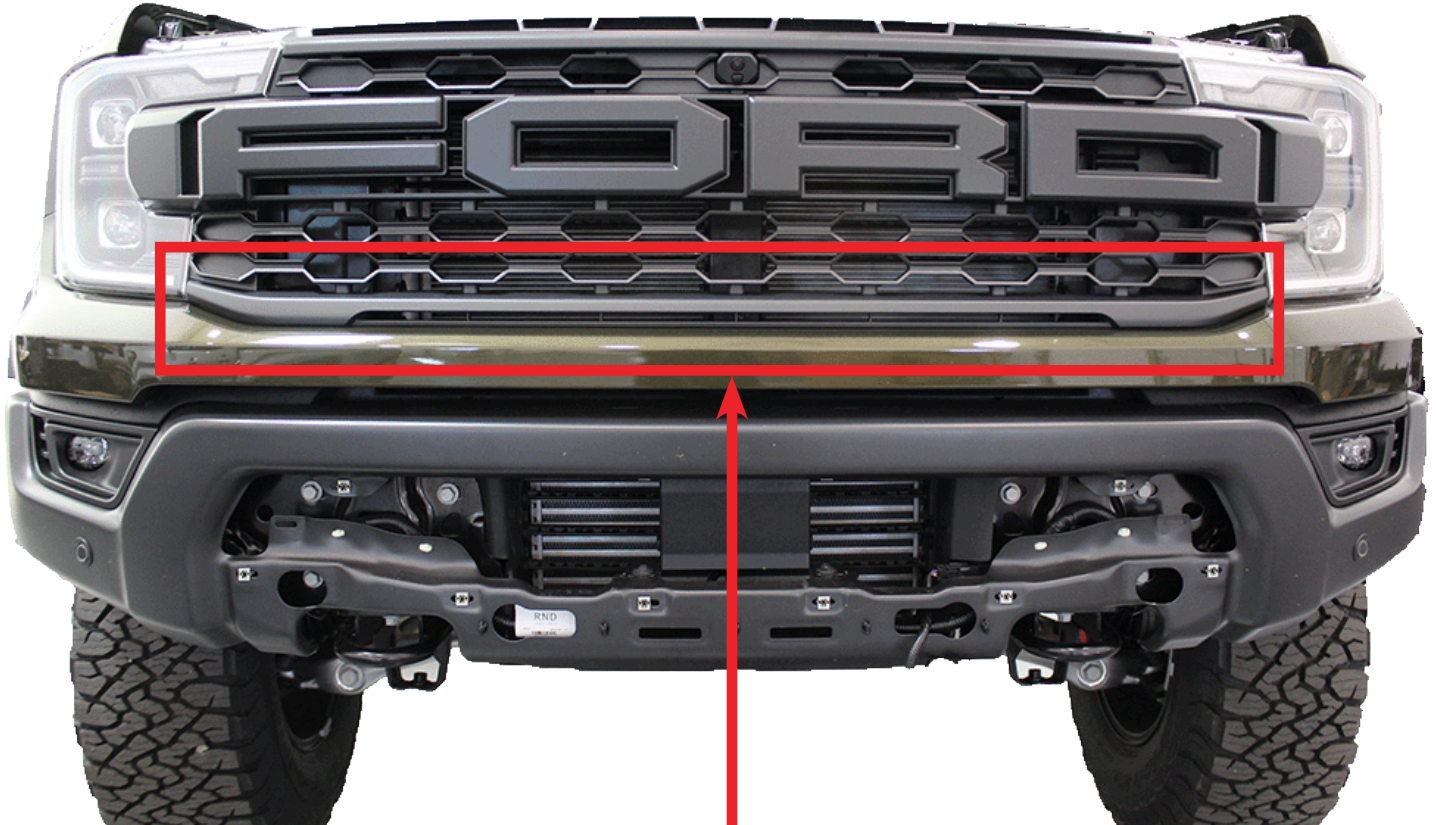



INSTALLATION **GUIDE**

PHANTOM FRONT BUMPER 24/FORD RANGER RAPTOR

REMOVAL

STEP 6

Next, using a (8mm socket) remove the hardware from the grill circled below.

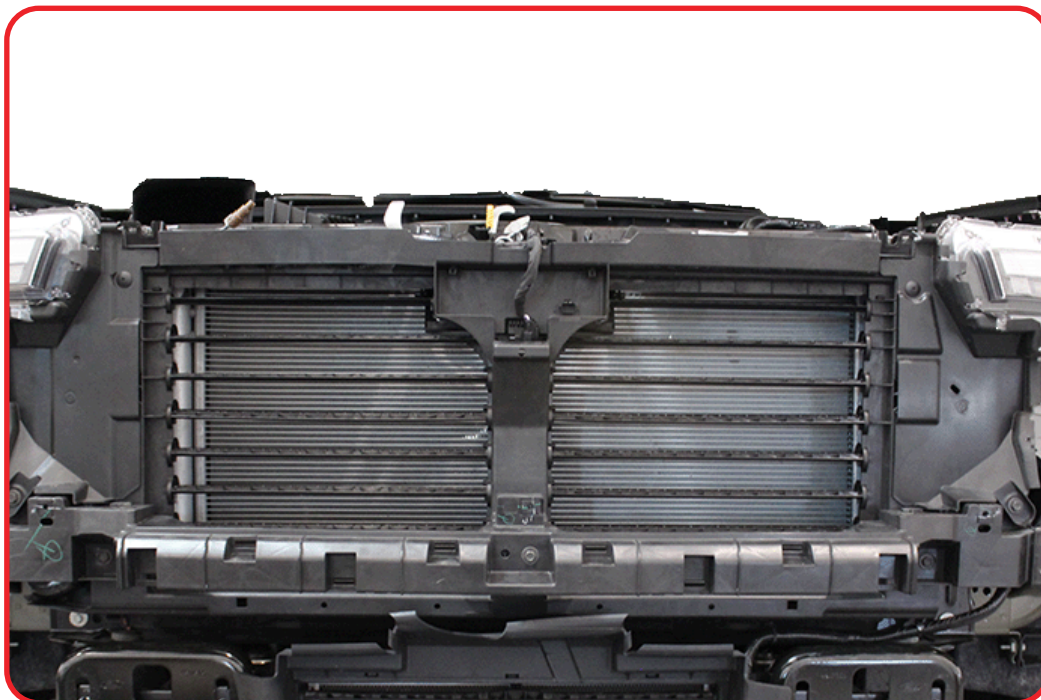
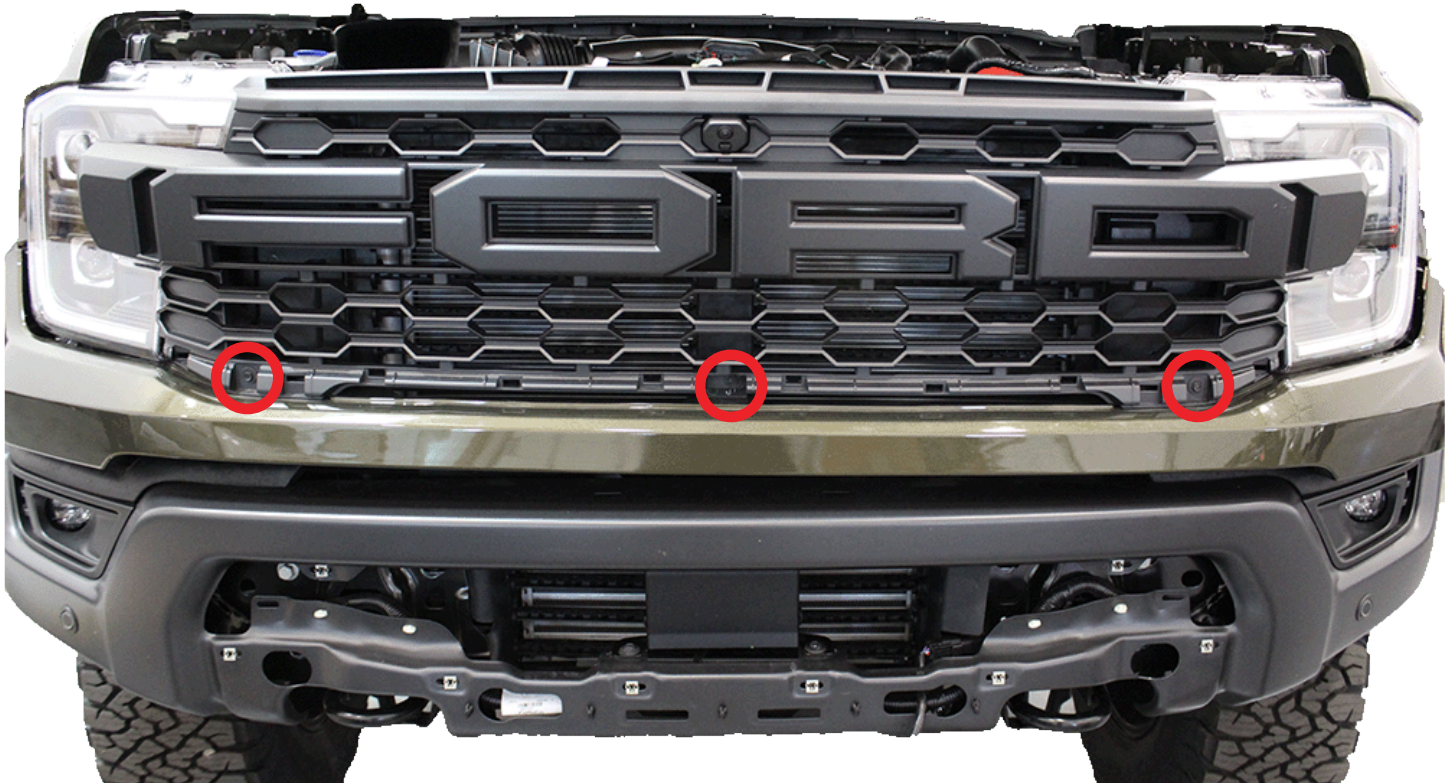

PHANTOM FRONT BUMPER 24/FORD RANGER RAPTOR

REMOVAL

□ STEP 7

Using a (T20) remove the hardware holding the fender located inside the wheel well.



PHANTOM FRONT BUMPER 24/FORD RANGER RAPTOR

REMOVAL

□ STEP 8

Pull the fender outwards and unplug the plug located inside the fender near the bumper.





INSTALLATION GUIDE

PHANTOM FRONT BUMPER 24/FORD RANGER RAPTOR

REMOVAL

□ STEP 9

Using a (10mm socket) remove the hardware holding the valence located behind the fender above the bumper.



PHANTOM FRONT BUMPER 24/FORD RANGER RAPTOR

REMOVAL

□ STEP 10

Using a (fastener remover/flat head screwdriver) remove the clips holding the top cover as shown below.

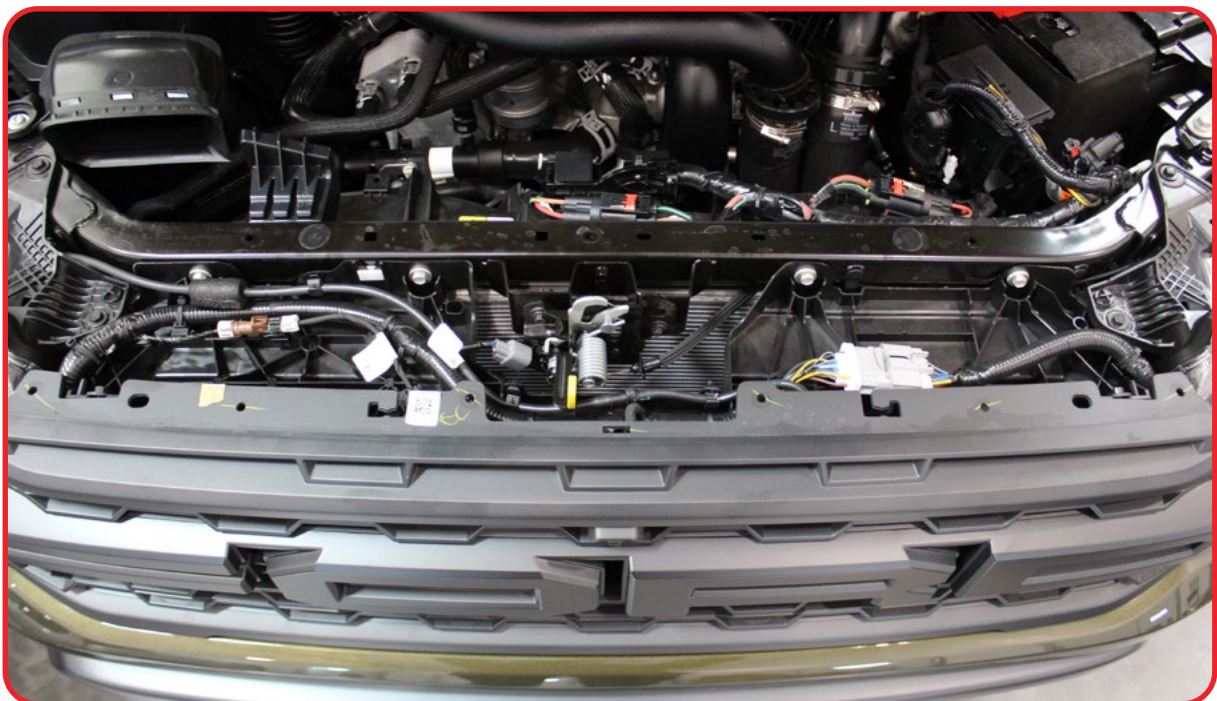
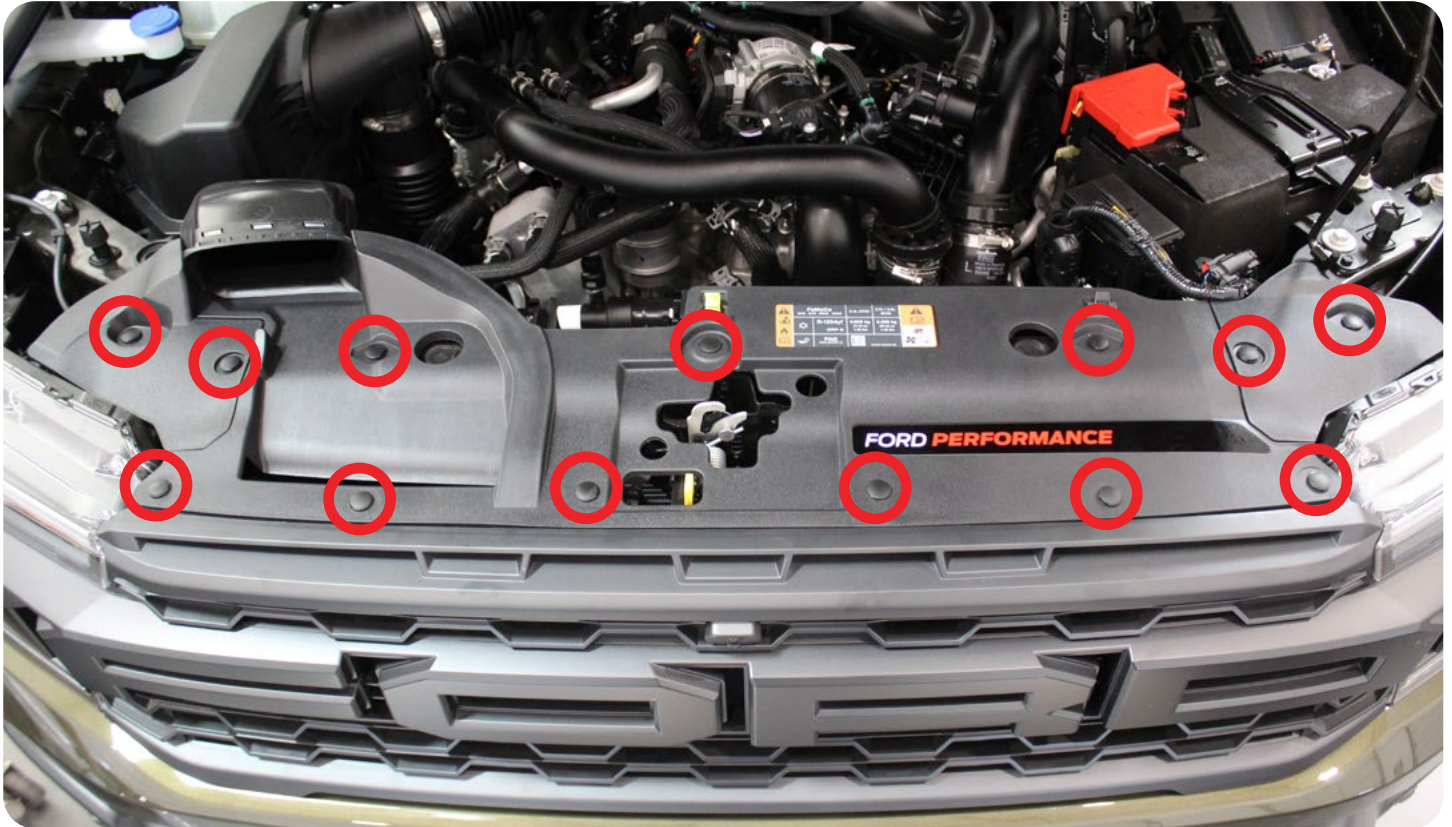

PHANTOM FRONT BUMPER 24/FORD RANGER RAPTOR

REMOVAL

□ STEP 11

Using a (10mm socket) and twisting the clip to remove the hardware circled below.

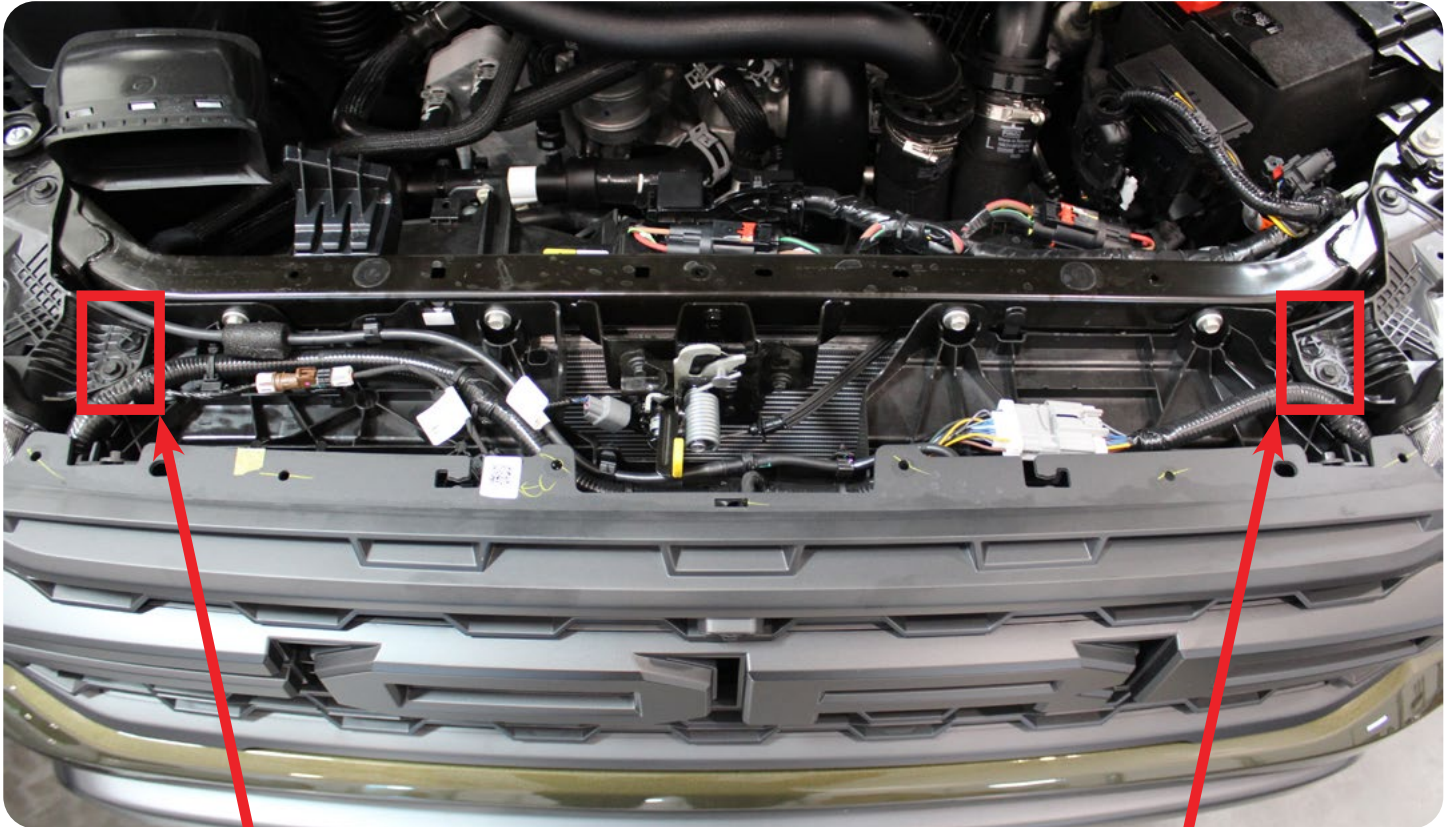

PHANTOM FRONT BUMPER 24/FORD RANGER RAPTOR

REMOVAL

□ STEP 12

Using a (10mm socket) remove the hardware holding the grill.

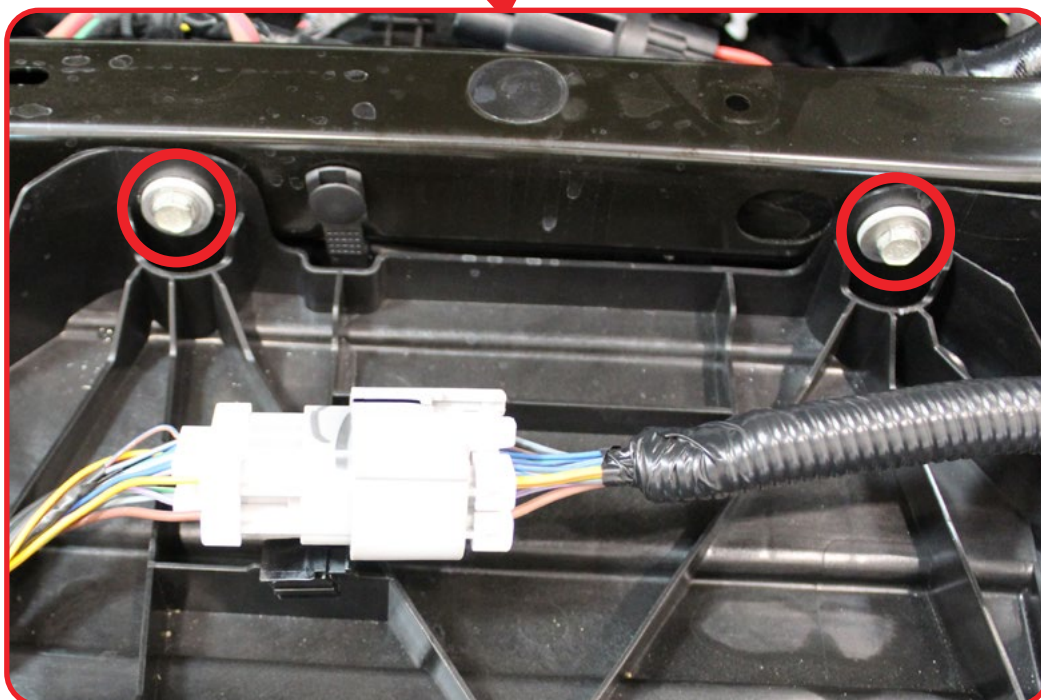
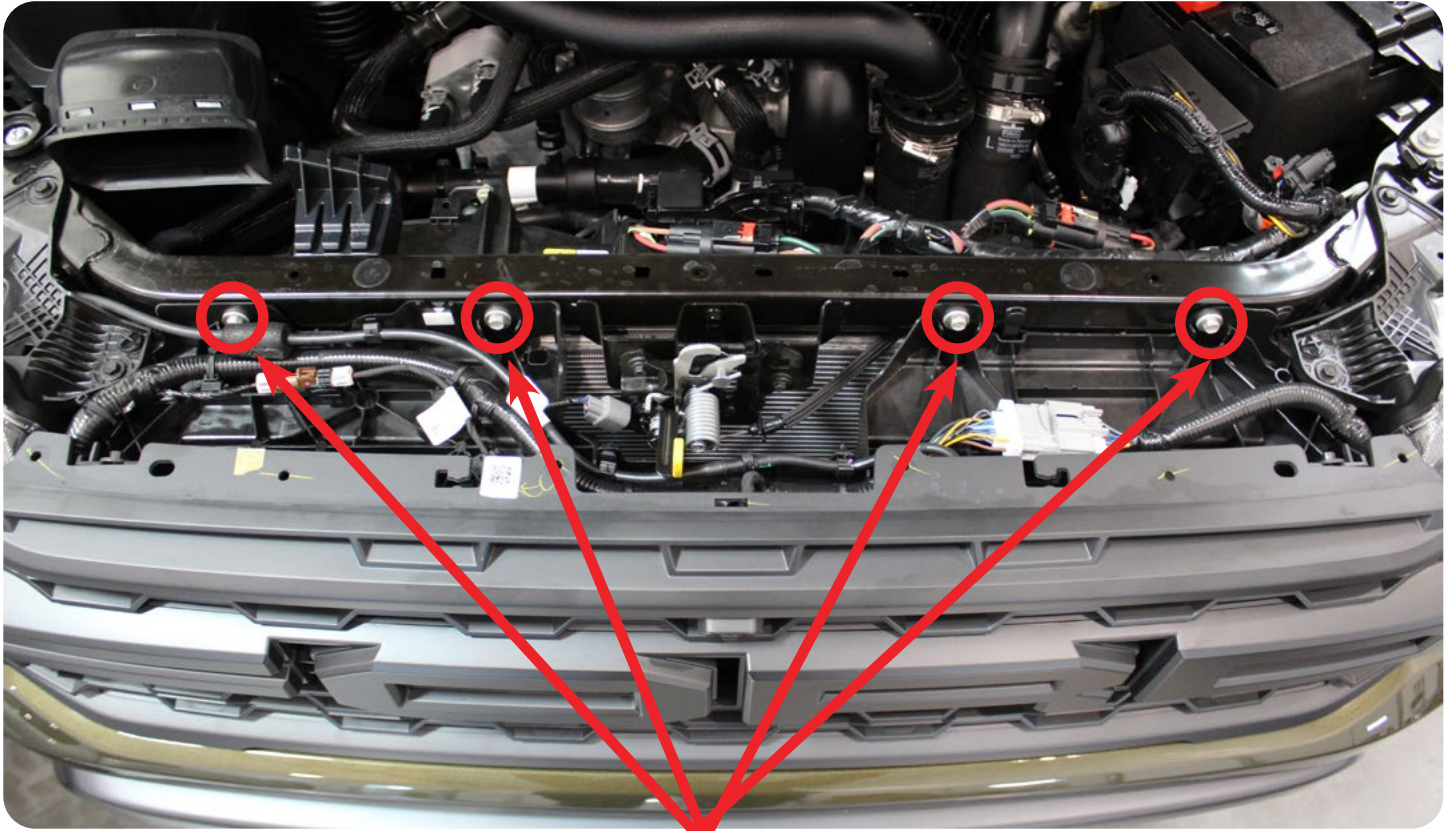

PHANTOM FRONT BUMPER 24/FORD RANGER RAPTOR

REMOVAL

□ STEP 13

Unplug the wire harness plug in located on the driver side by the headlight.

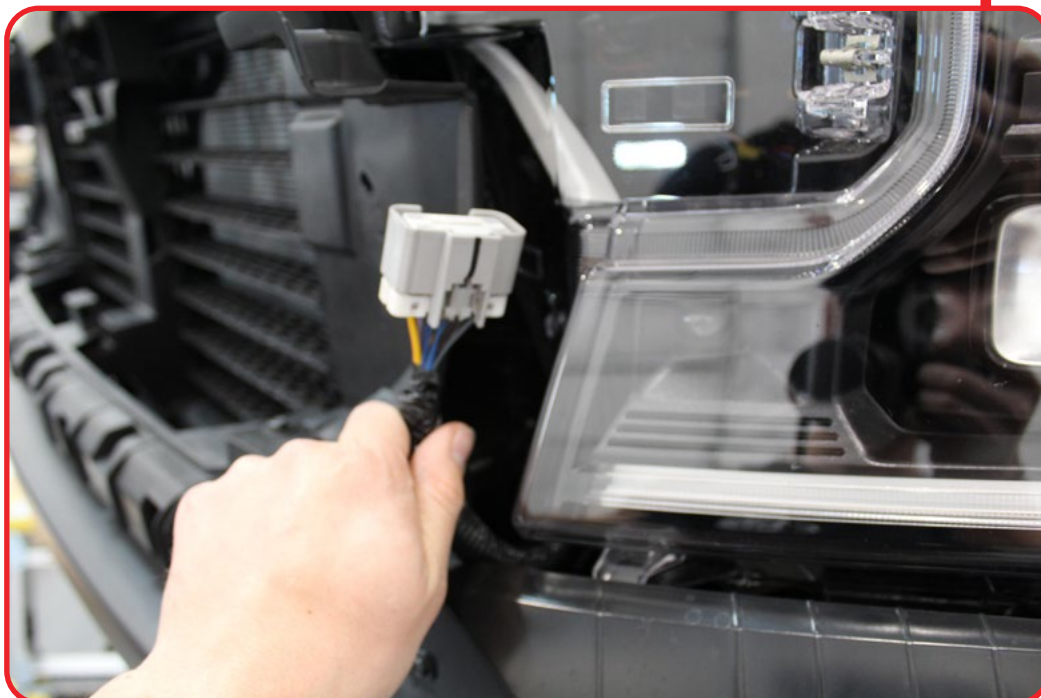

PHANTOM FRONT BUMPER 24/FORD RANGER RAPTOR

REMOVAL

□ STEP 14

Using a (15mm socket) remove the mounting hardware holding the bumper to the frame horns.

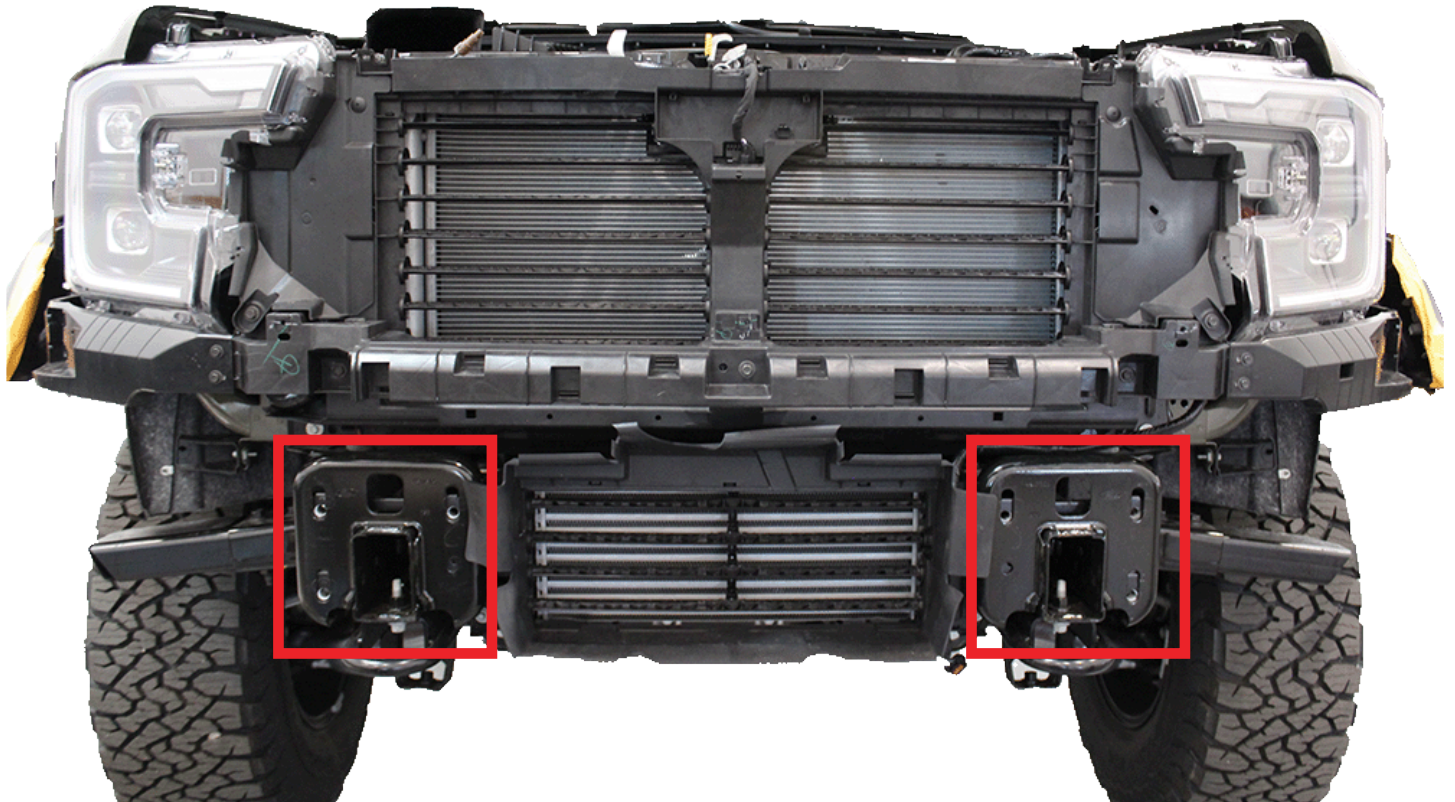



INSTALLATION GUIDE

PHANTOM FRONT BUMPER 24/FORD RANGER RAPTOR

REMOVAL

□ STEP 15

If your vehicle is equipped with an Adaptive Cruise Control please install before moving on with the phantom front install. You can find the install guide on the Addictive Desert Designs website.



PHANTOM FRONT BUMPER 24/FORD RANGER RAPTOR

REMOVAL

□ STEP 16

Using a (5/16 wrench) remove the hardware holding the shutter housing located above the frame horns.

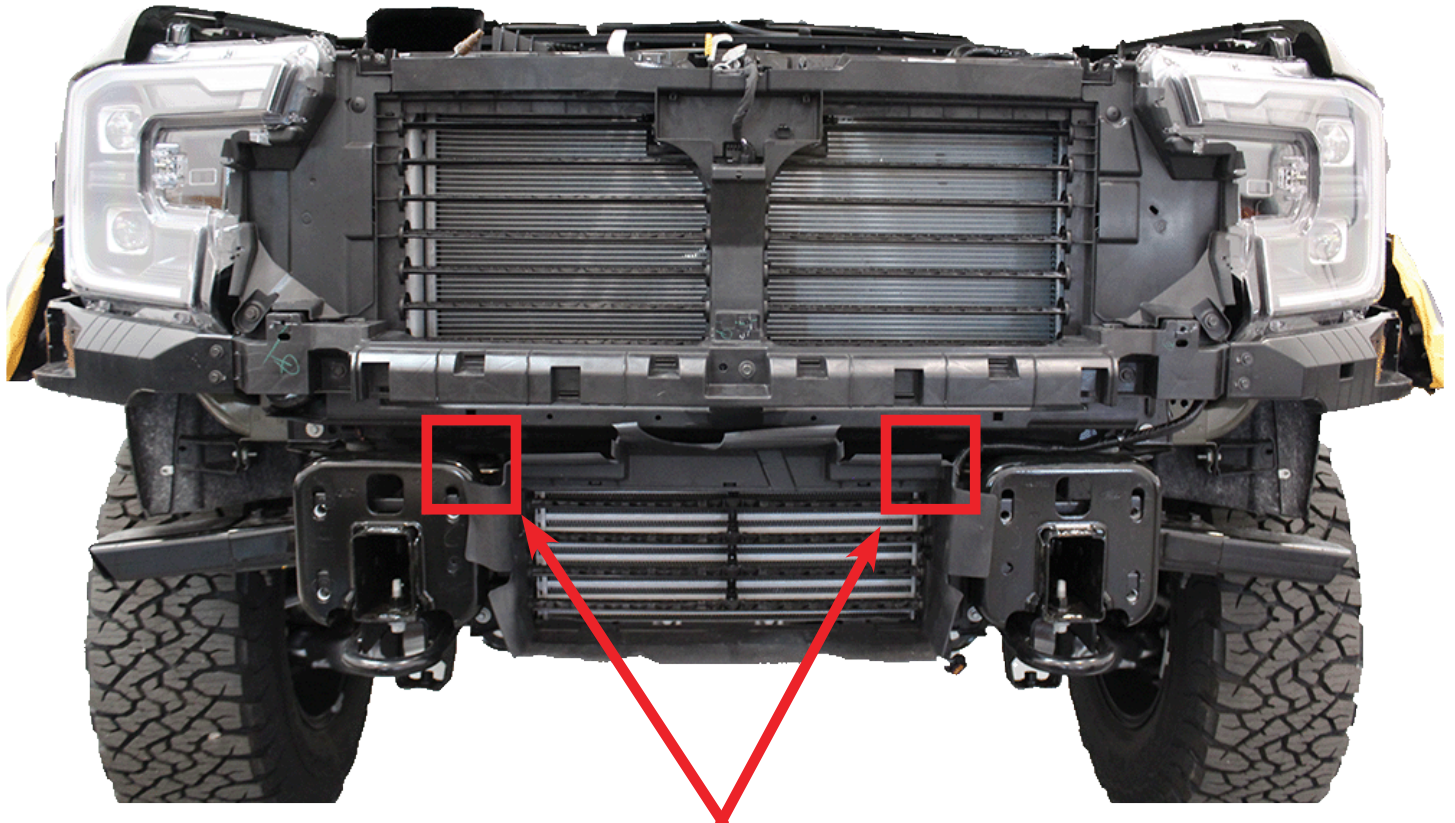

PHANTOM FRONT BUMPER 24/FORD RANGER RAPTOR

REMOVAL

□ STEP 17

Using a (5/16 wrench) remove the hardware holding the shutter housing located below the frame horns.

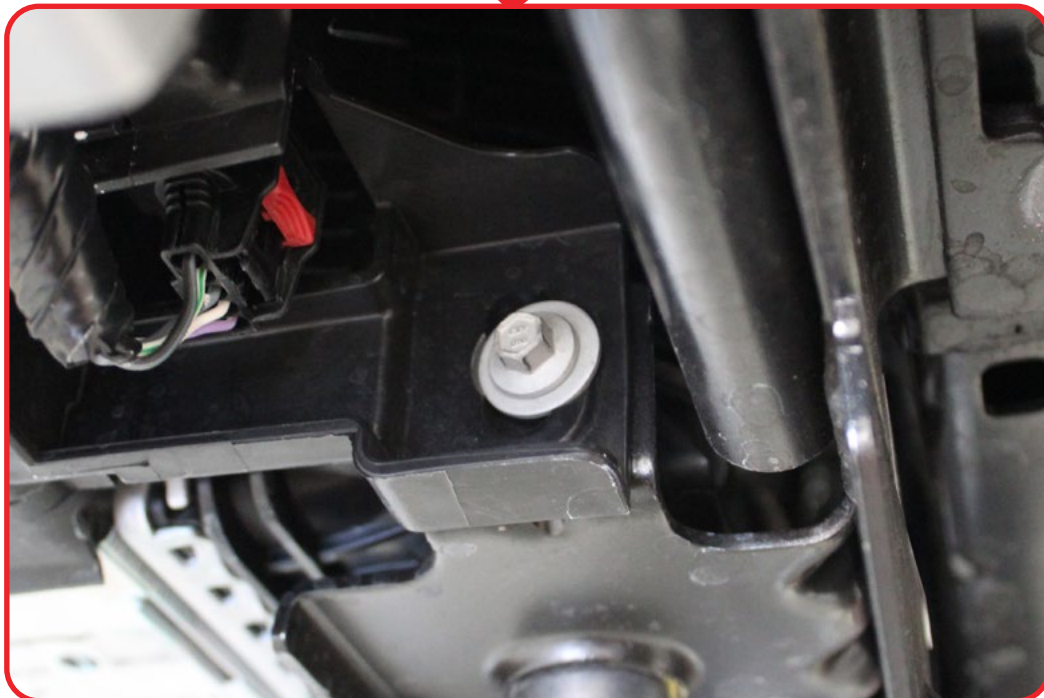
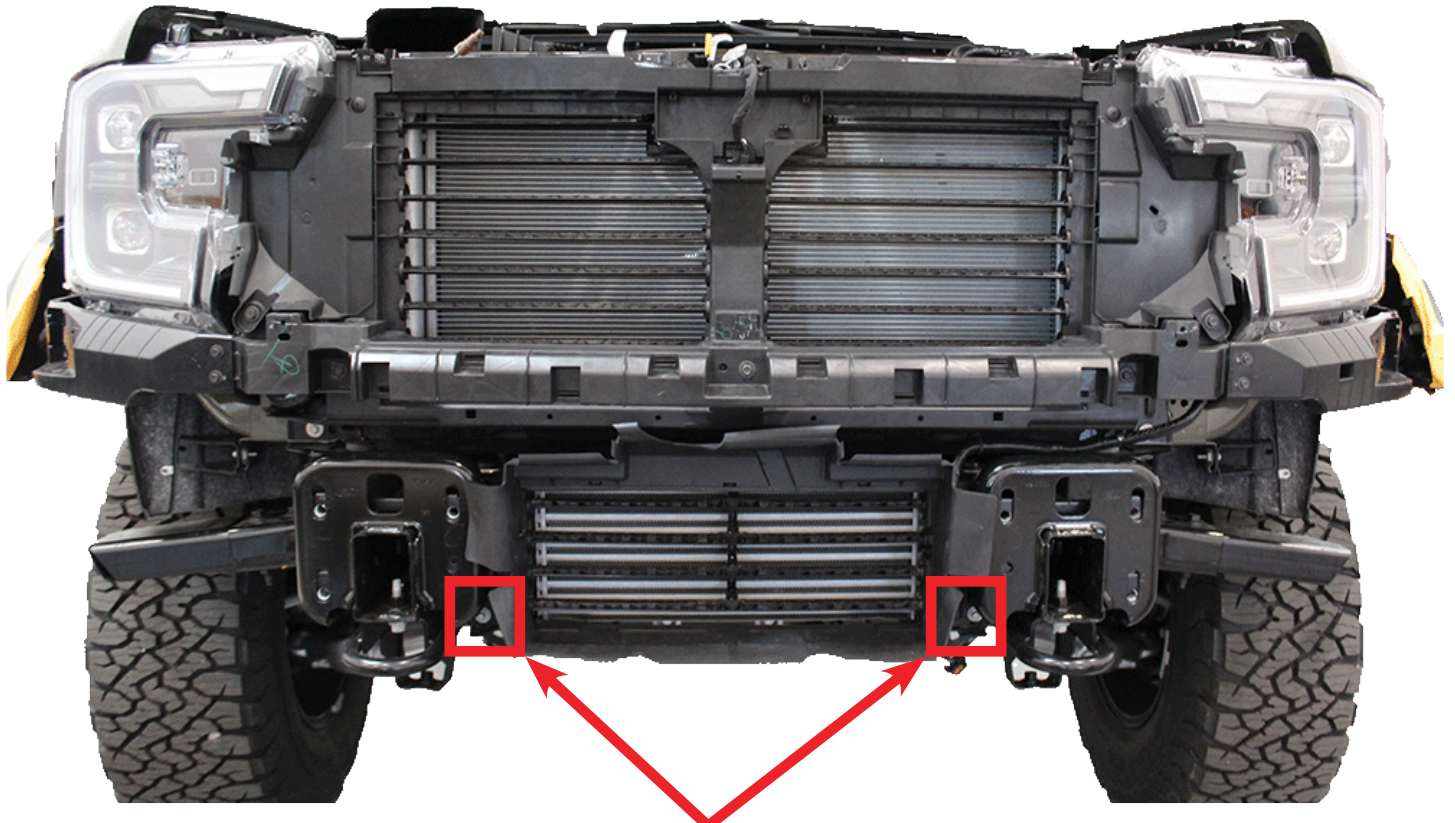

PHANTOM FRONT BUMPER 24/FORD RANGER RAPTOR

REMOVAL

□ STEP 18

(OPTIONAL) Using a (15mm socket) remove the tow hooks located under the frame horns.

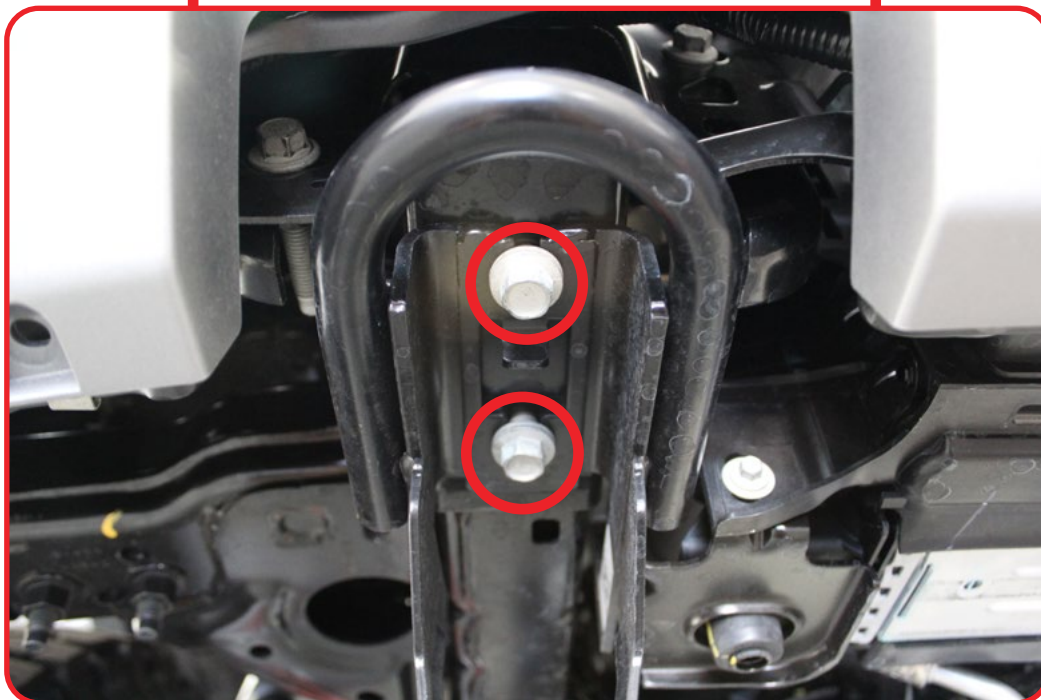
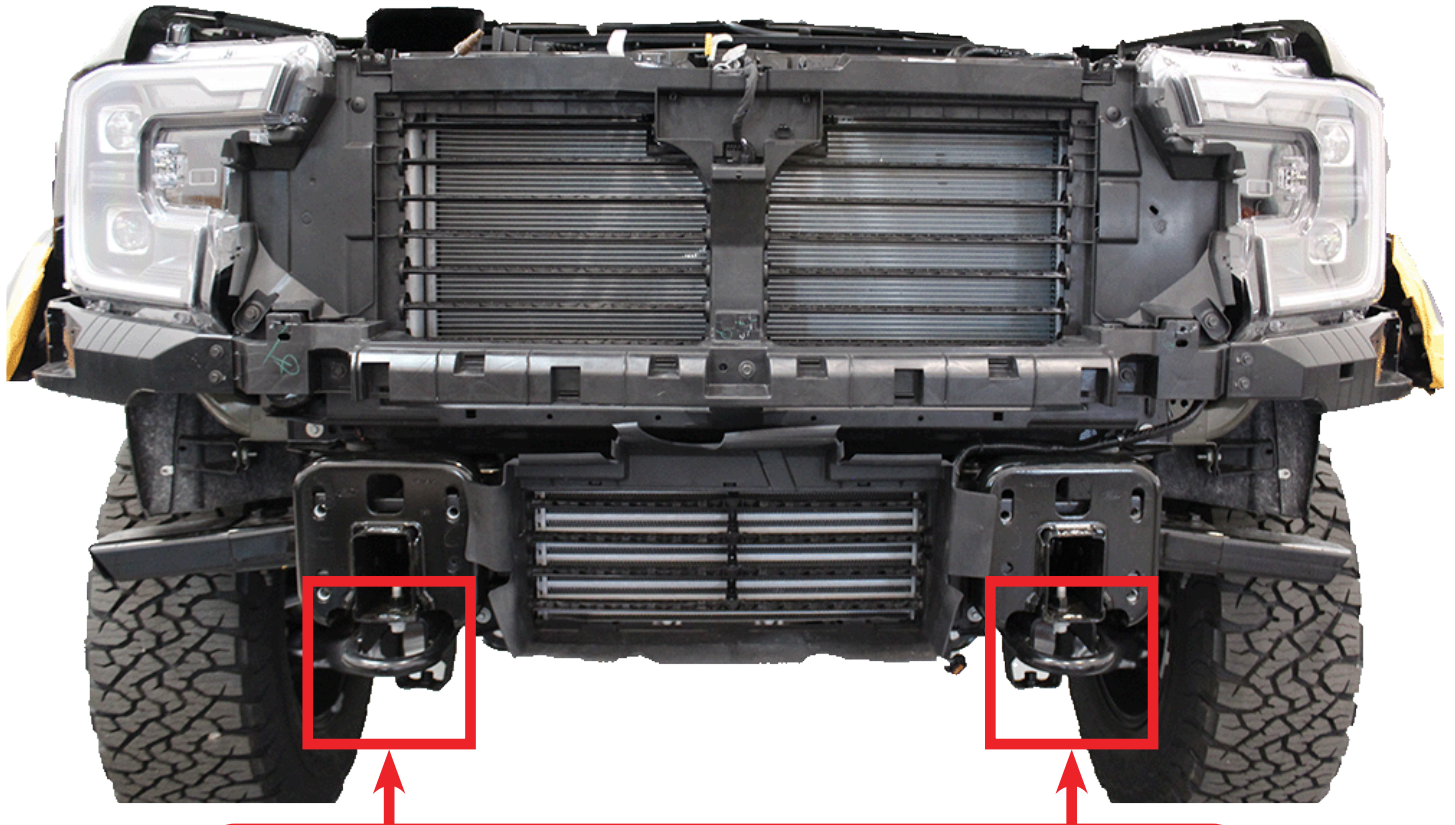

PHANTOM FRONT BUMPER 24/FORD RANGER RAPTOR

REMOVAL

□ STEP 19

Using a (15mm socket) remove the side supports as shown below.

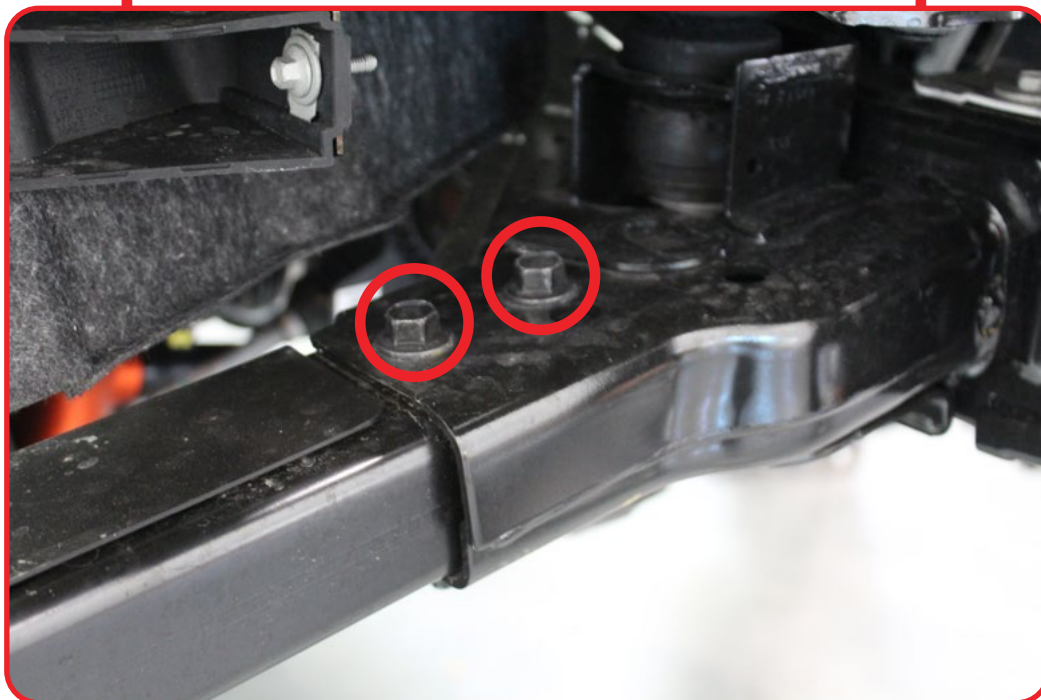
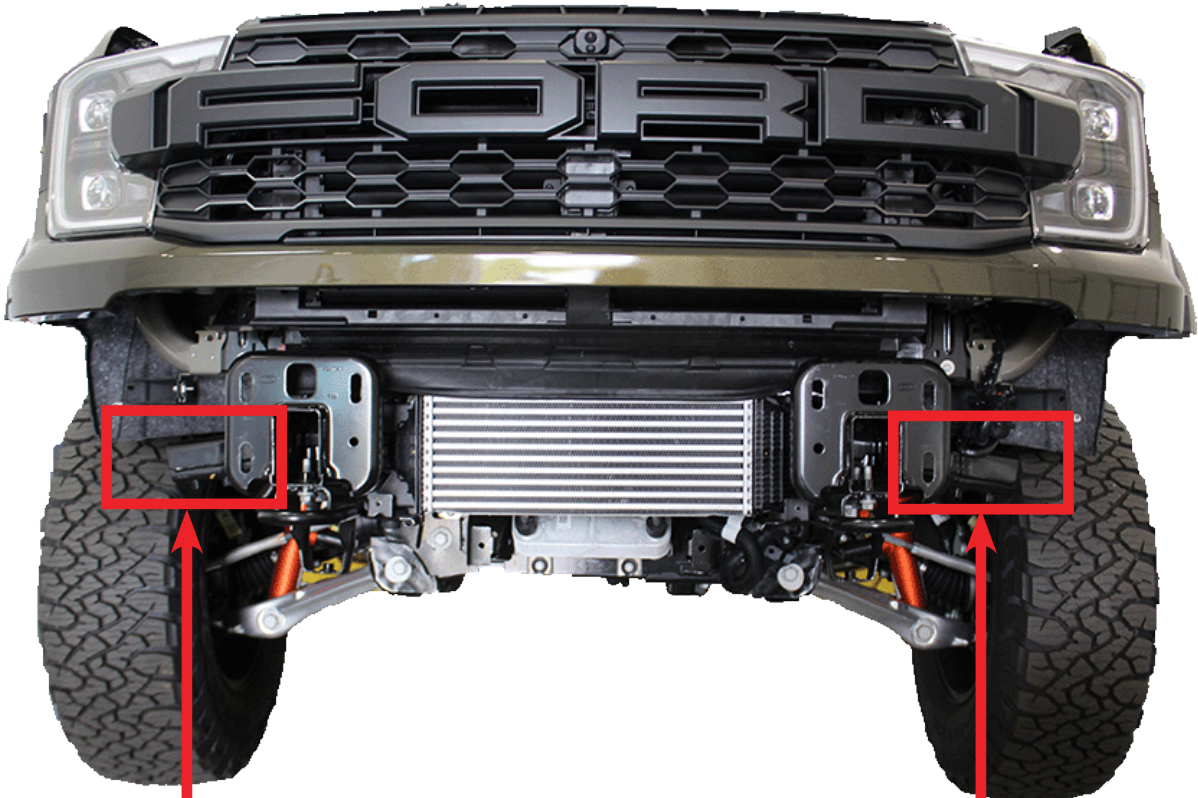

PHANTOM FRONT BUMPER 24/FORD RANGER RAPTOR

REMOVAL

□ STEP 20

Remove the plastic nuts holding the nut plate on the back of the frame horn.

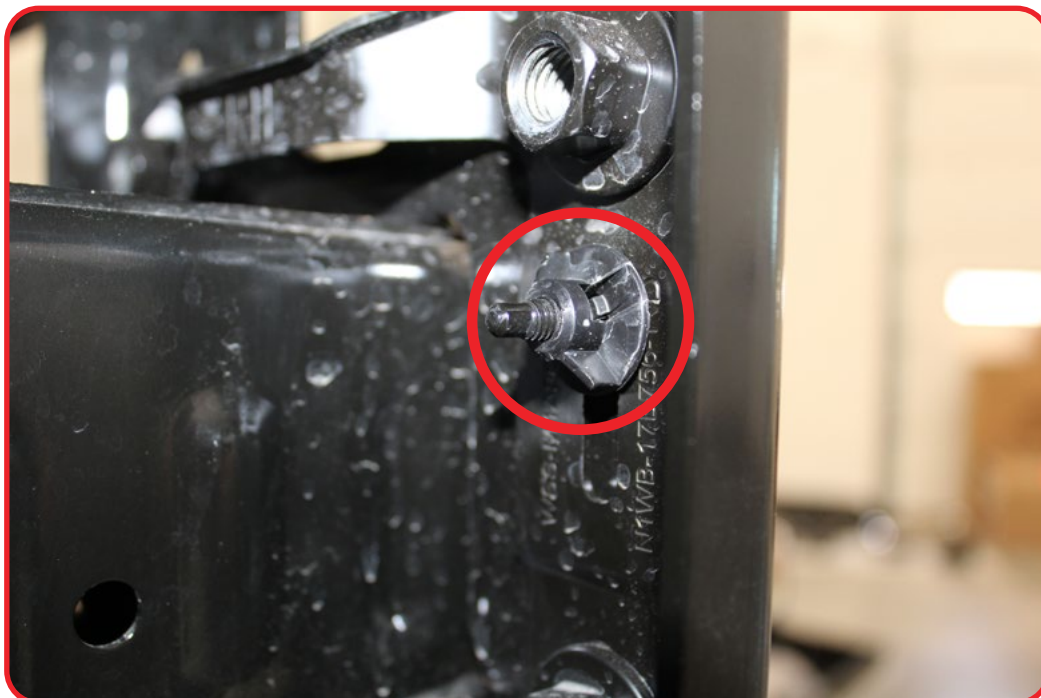

PHANTOM FRONT BUMPER 24/FORD RANGER RAPTOR

REMOVAL

□ STEP 21

Using your finger, push in on the side of the shutter blade to release. Next remove the shutter motor and plug back in and zip tie to the wire harness. ****DO NOT ZIP TIE THROUGH ROTATING HOLE****



PHANTOM FRONT BUMPER 24/FORD RANGER RAPTOR

REMOVAL

□ STEP 22

Using a (10mm socket) remove all the covers on the back of the OEM bumper to expose the wiring harness.

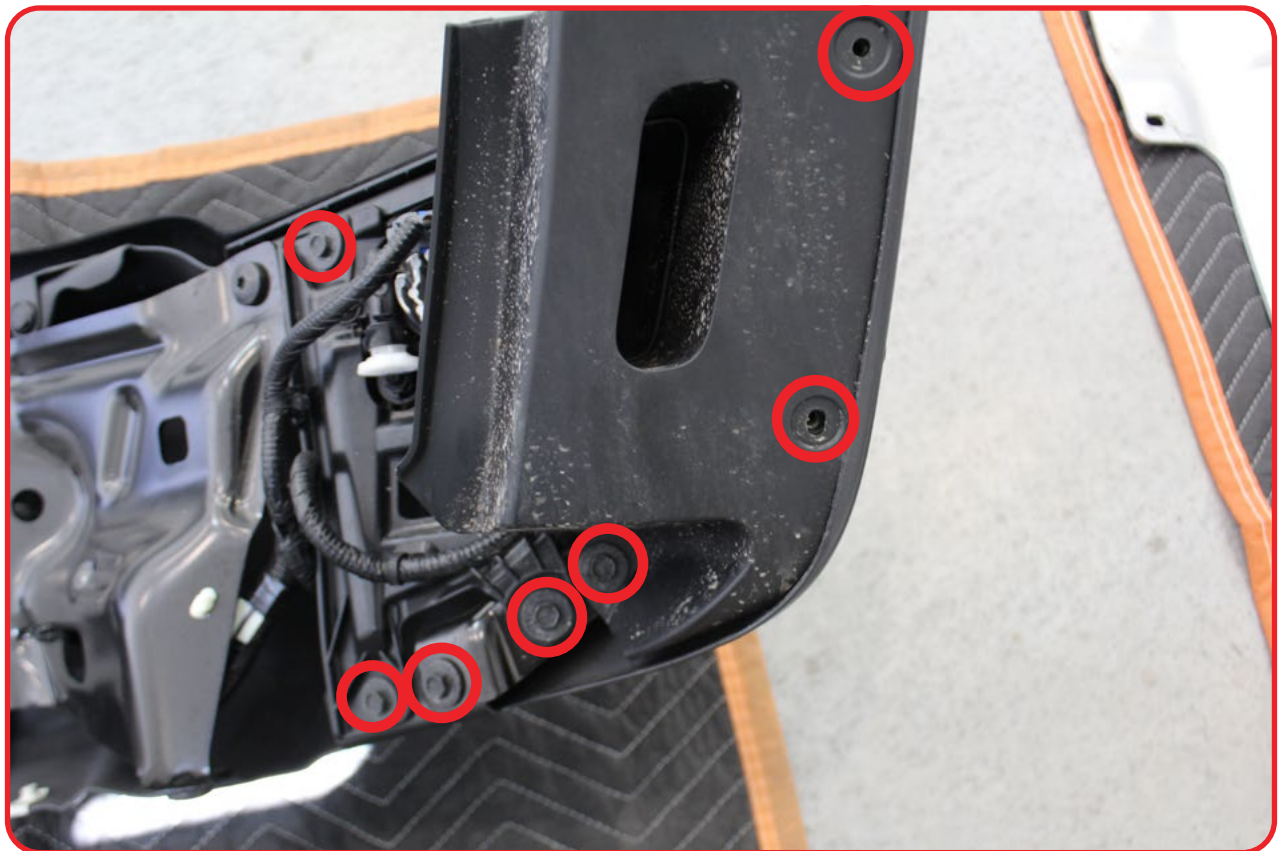

PHANTOM FRONT BUMPER 24/FORD RANGER RAPTOR

REMOVAL

□ STEP 23

Remove all four parking sensors and bezels from the stock bumper and remove wire harness.

****Remember the orientation and positions for later****

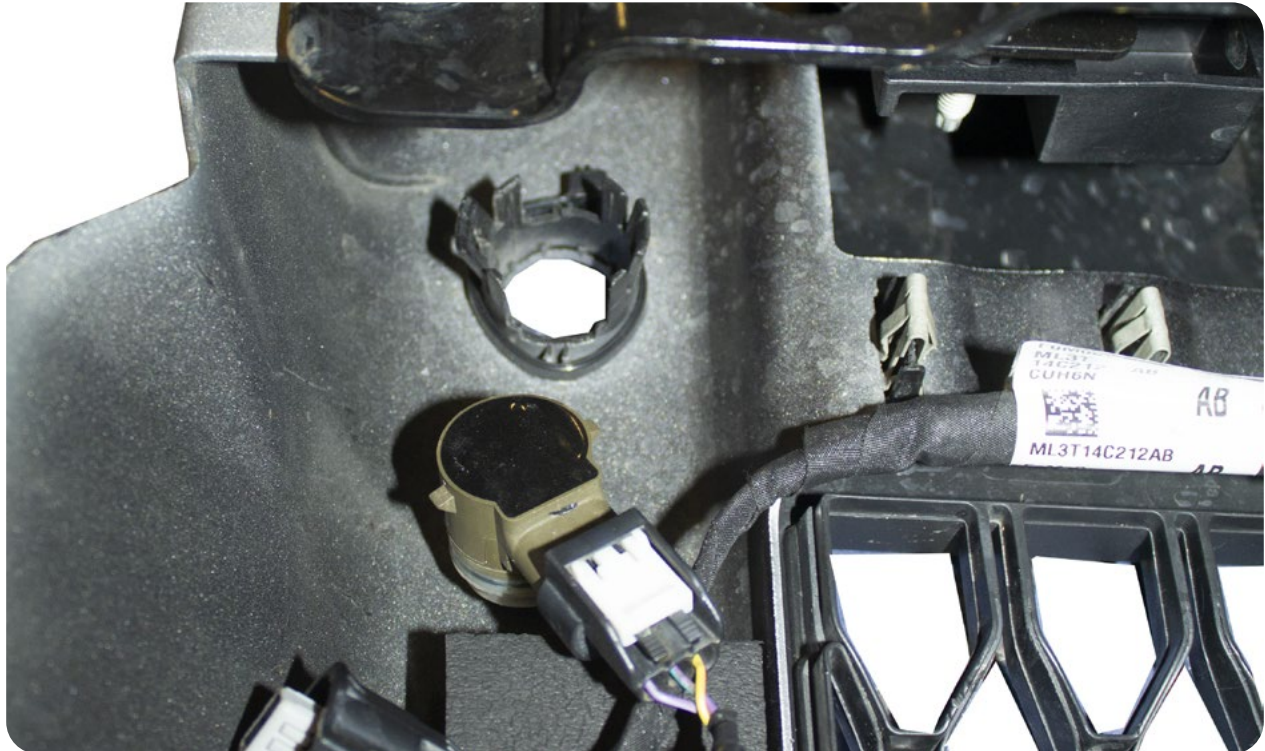

Spread these two tabs to release the sensor from its mounting ring.



PHANTOM FRONT BUMPER 24/FORD RANGER RAPTOR

REMOVAL

□ STEP 24

Using a (flat head screwdriver) or a (razor blade), remove the sensor bezels from the plastic cover removed from step 3. ****Remember the orientation and positions for later****



PHANTOM FRONT BUMPER 24/FORD RANGER RAPTOR

INSTALL

□ STEP 26

Remove double sided tape from the bezel until the surface is clear of residue.

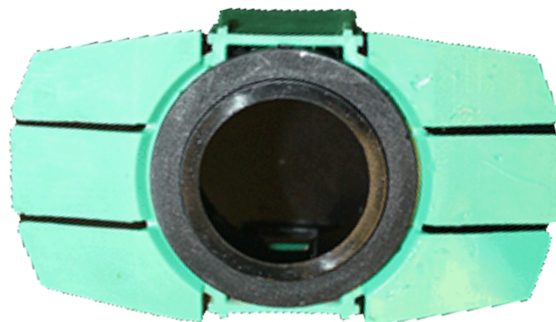



INSTALLATION GUIDE

PHANTOM FRONT BUMPER 24/FORD RANGER RAPTOR

INSTALL

□ STEP 27

Install the provided (G) 3m double sided tape to each side of the bezel wings and trim excess with a (razor blade).

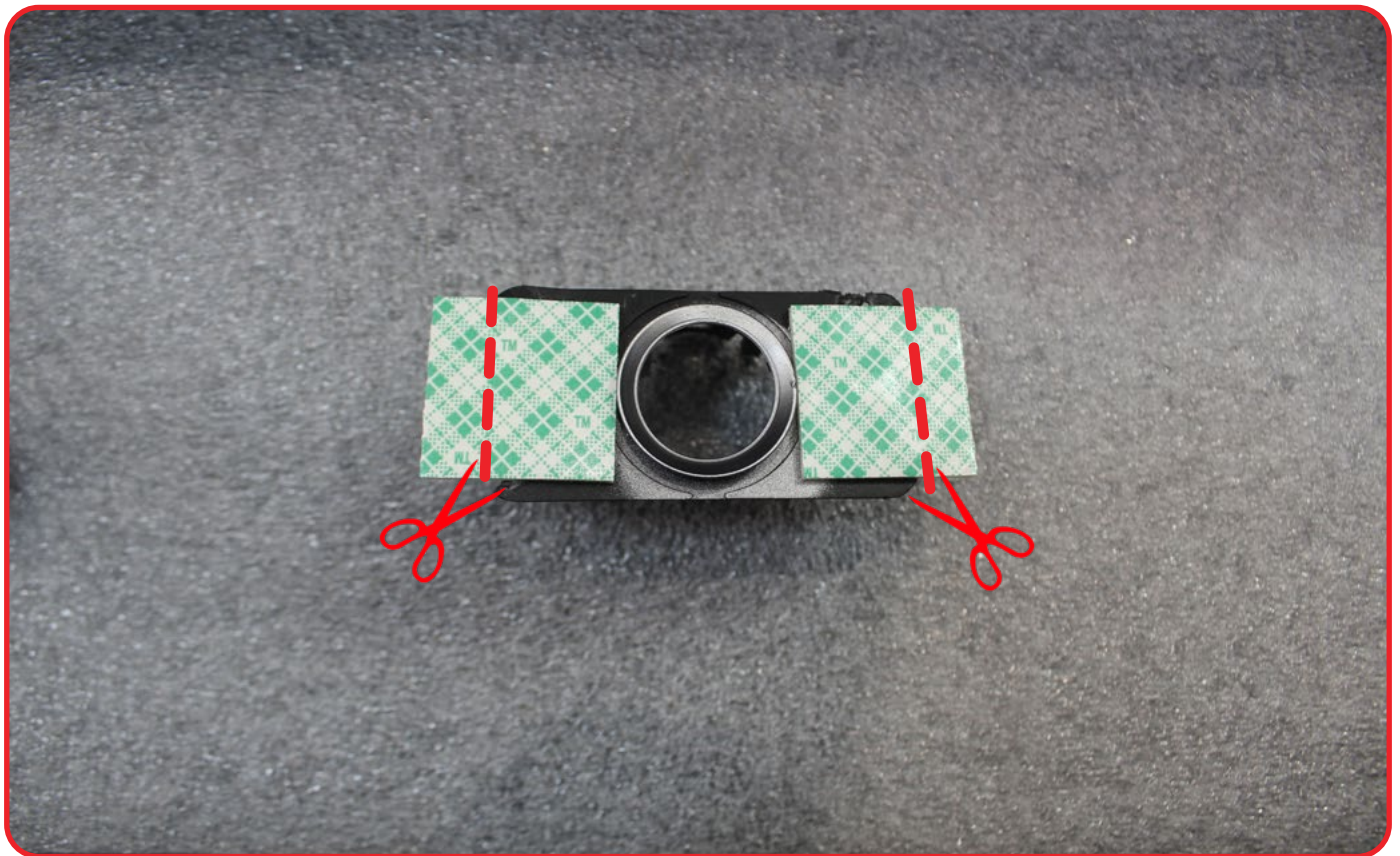

PHANTOM FRONT BUMPER 24/FORD RANGER RAPTOR

INSTALL

□ STEP 28

Install the sensor bezels removed from **step 3** in the correct orientation and positions as shown below. ****If they do not stick, wipe the surface clean and re install****

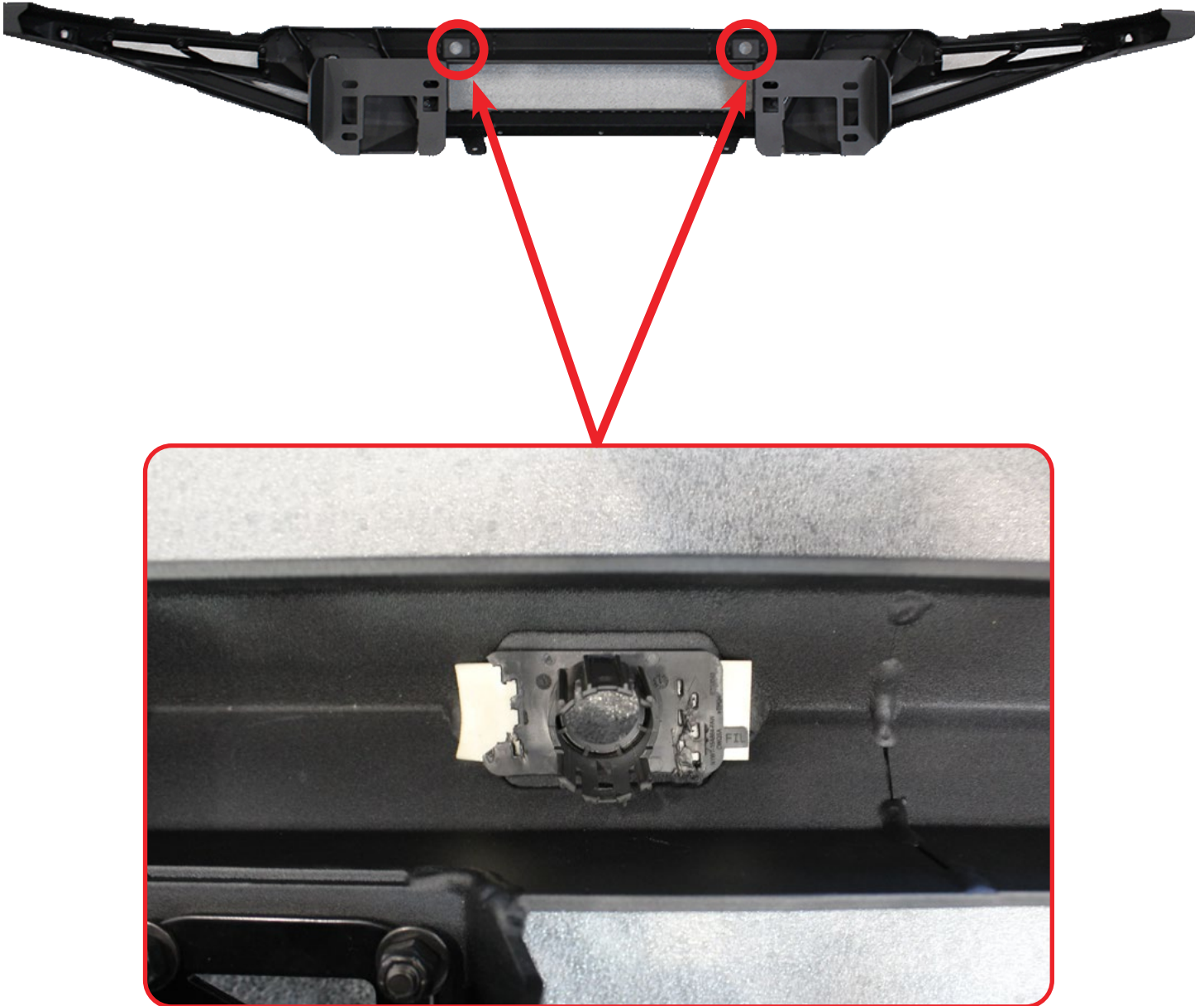

PHANTOM FRONT BUMPER 24/FORD RANGER RAPTOR

INSTALL

□ STEP 29

Install the sensor bezels into the ADD bumper. ****If the bezels do not click into place you may have to trim the tabs to match the thickness of the bumper as shown below****

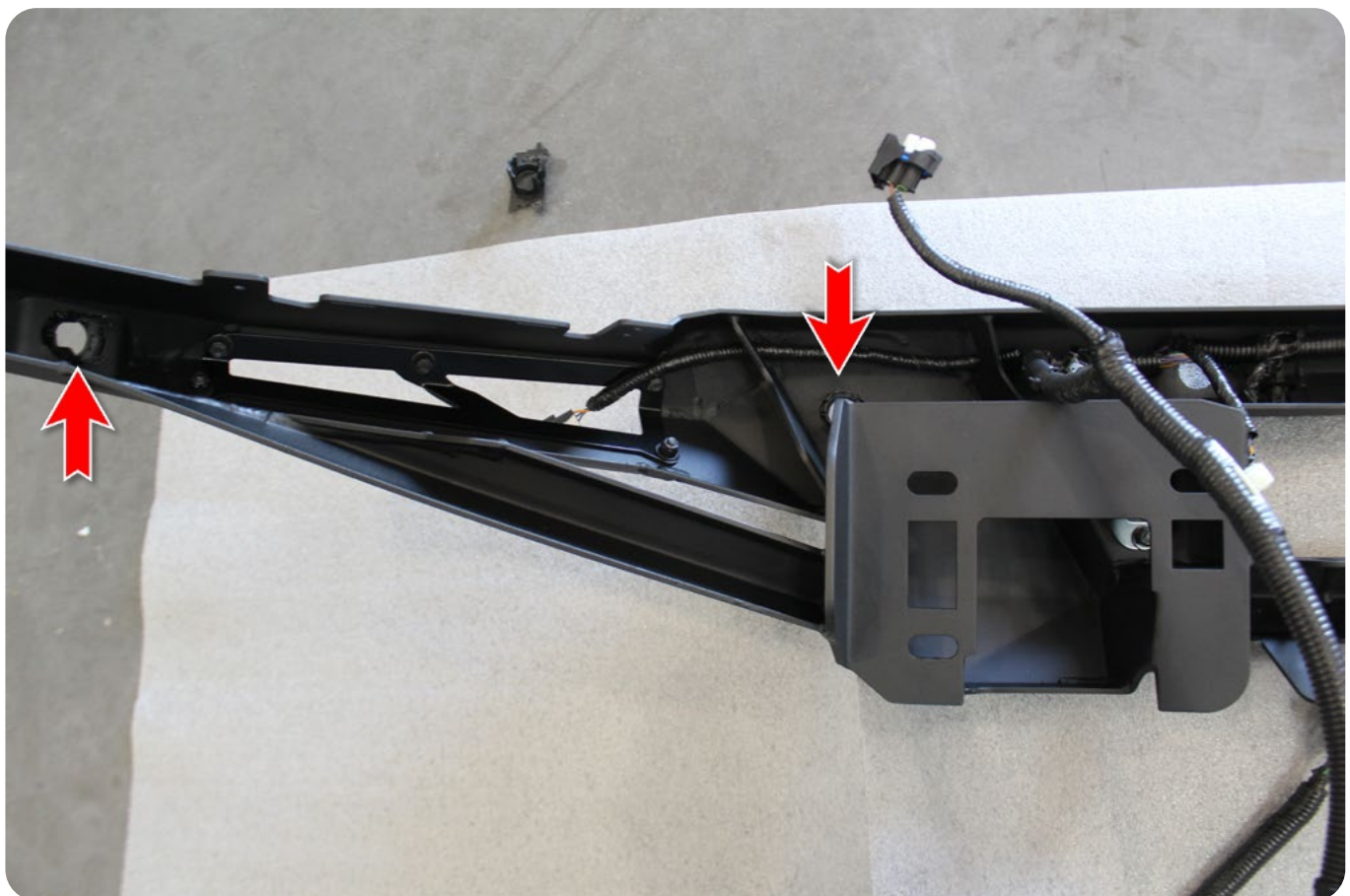
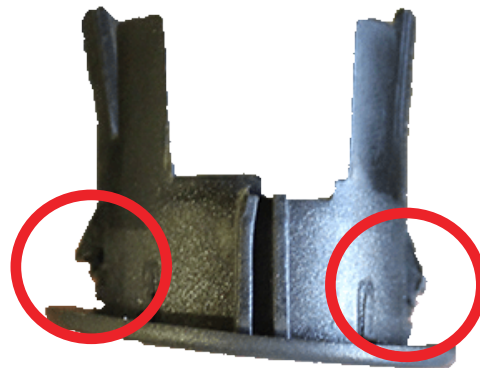
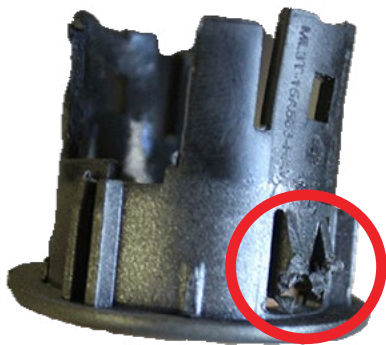



INSTALLATION GUIDE

PHANTOM FRONT BUMPER 24/FORD RANGER RAPTOR

INSTALL

□ STEP 30

Install the wire harness with the plug in on the driver side.

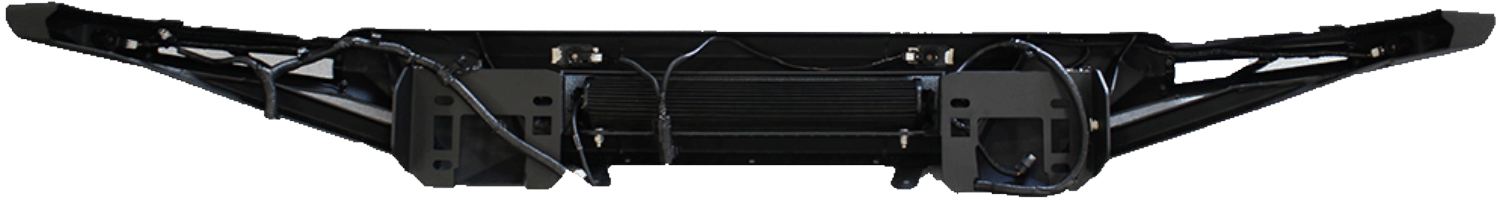



INSTALLATION GUIDE

PHANTOM FRONT BUMPER 24/FORD RANGER RAPTOR

INSTALL

□ STEP 31

Install the skid plate to the bumper with the provided (B, B1, B2) 3/8" hardware using a (7/32 allen wrench) and (9/16 wrench).

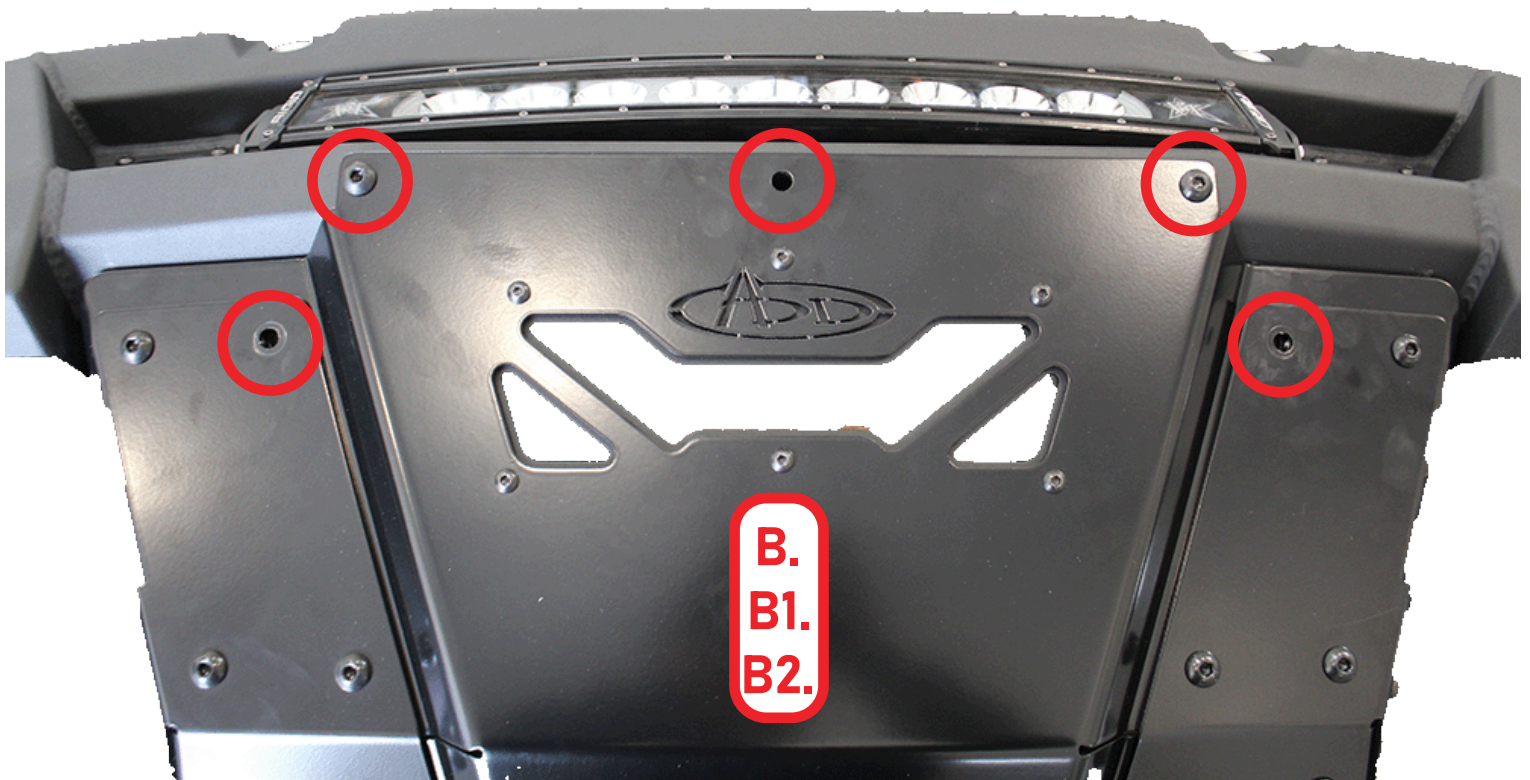

PHANTOM FRONT BUMPER 24/FORD RANGER RAPTOR

INSTALL

□ STEP 32

Install the provided (A2) 3/8" nut clips in the slots on the bumper. (Repeat on other side)

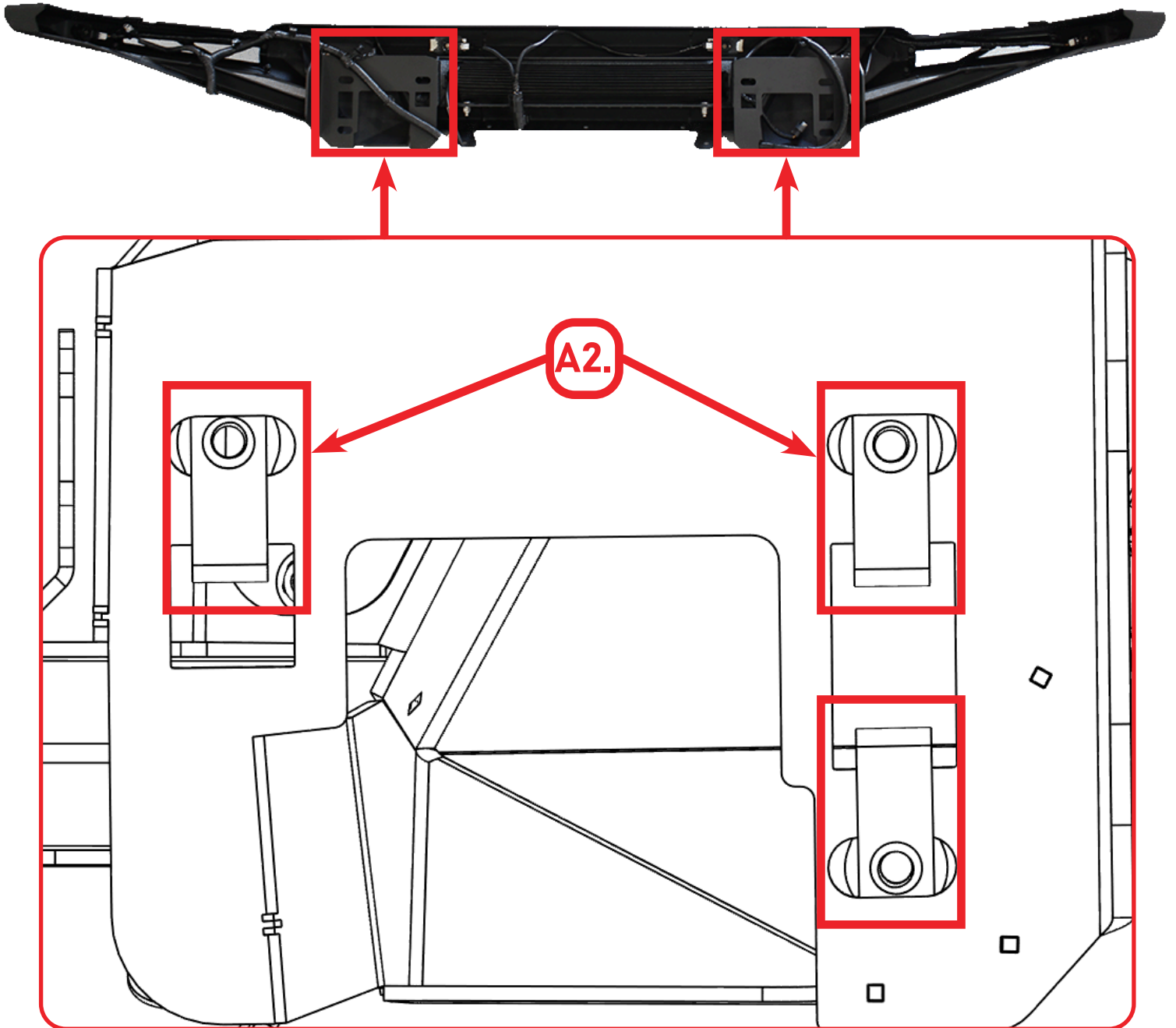



INSTALLATION GUIDE

PHANTOM FRONT BUMPER 24/FORD RANGER RAPTOR

INSTALL

□ STEP 33

Install the light brackets as shown below with the provided (D, D1, D2) 1/4" hardware using a (5/32 allen) and a (7/16 wrench).

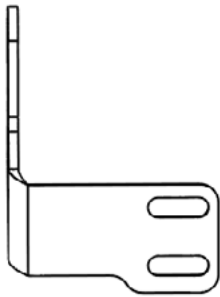

INSIDE



OUTSIDE

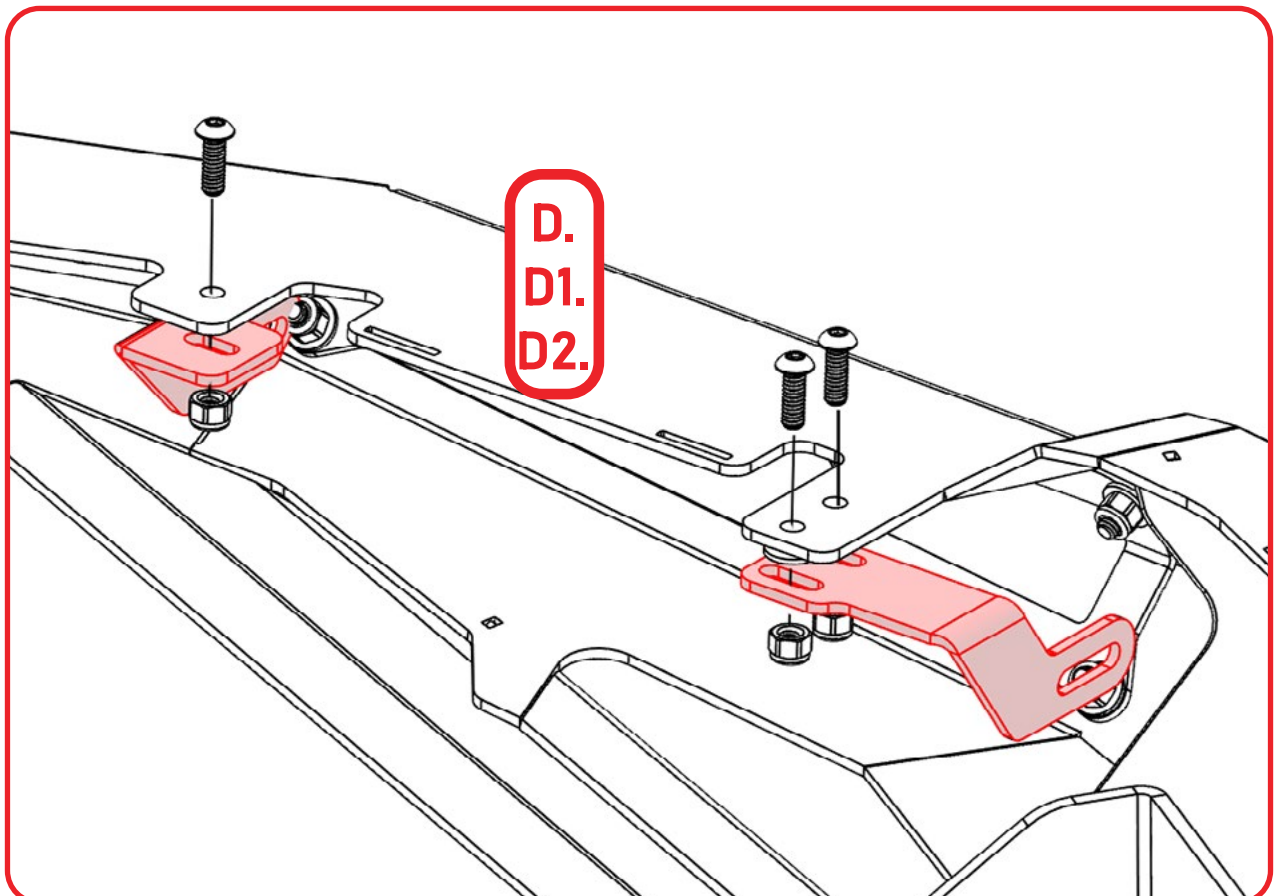

PHANTOM FRONT BUMPER 24/FORD RANGER RAPTOR

INSTALL

□ STEP 34

Remove the skid plate shown below using a (15mm socket) and using a (cutoff wheel/Grinder) trim the corner of the skid plate highlighted to expose the hidden threaded hole.

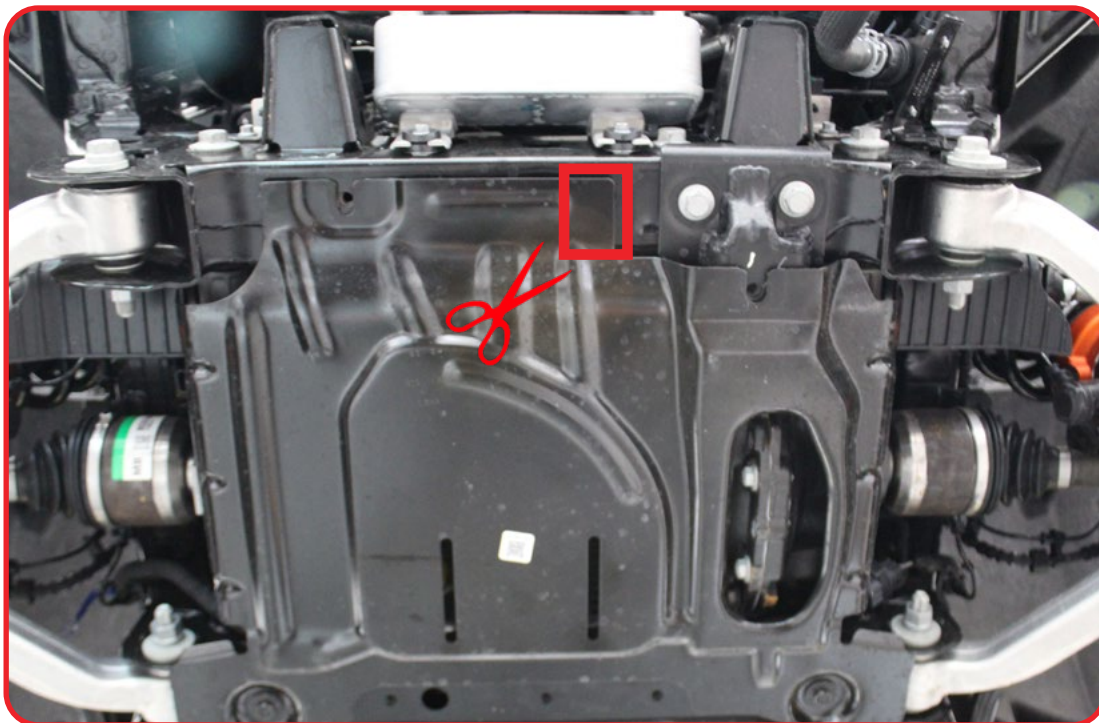
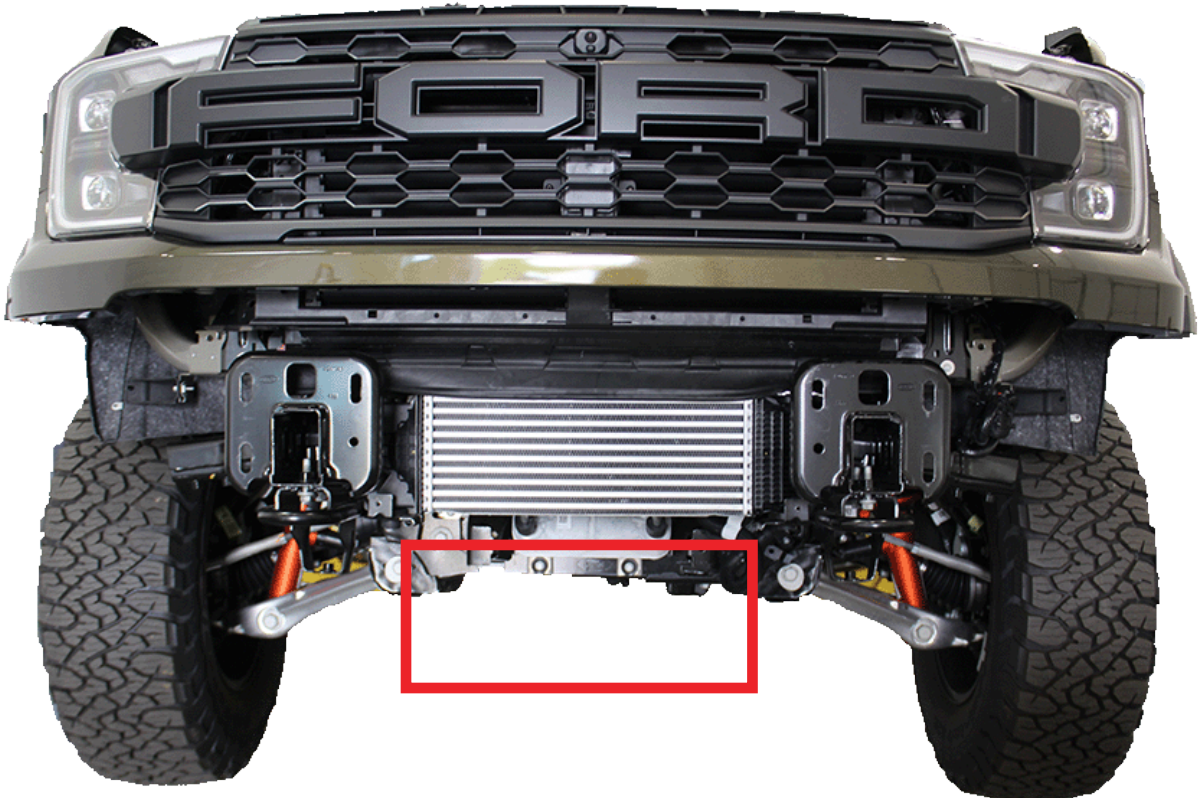



INSTALLATION GUIDE

PHANTOM FRONT BUMPER 24/FORD RANGER RAPTOR

INSTALL

□ STEP 35

With a helping hand, install the bumper with the provided (A, A1) 3/8" hardware using a (9/16 socket).
****Leave loose until the install is complete****

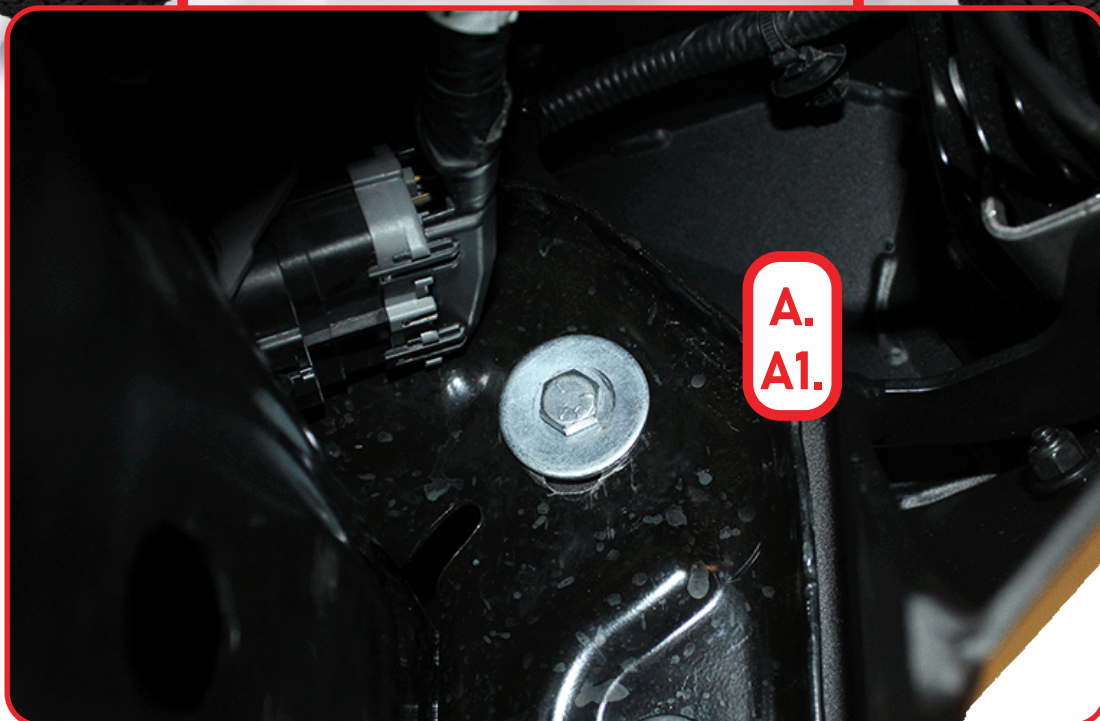
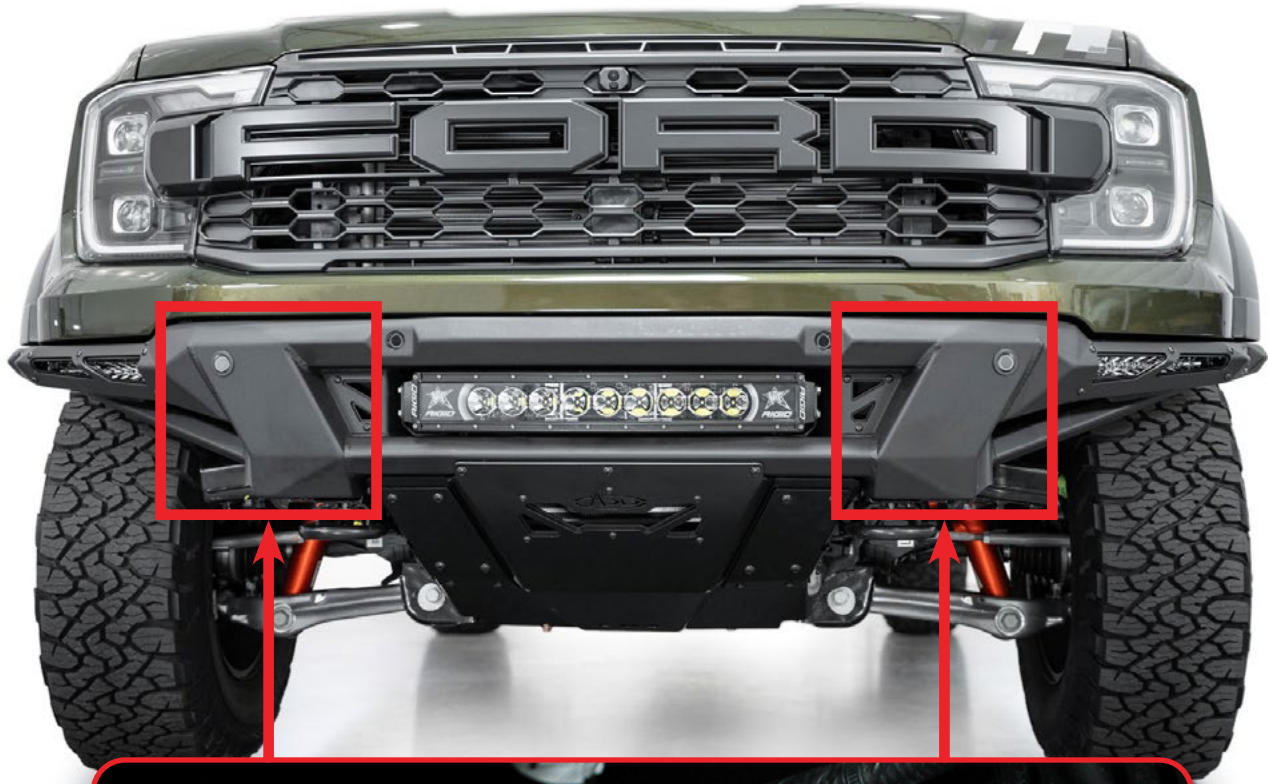



INSTALLATION GUIDE

PHANTOM FRONT BUMPER 24/FORD RANGER RAPTOR

INSTALL

STEP 36

Insert the skid plate spacer between the bumper and the frame and with the provided (F) M10 Bolts, and 1X skid plate bolt removed from step 1 install using a (15mm socket).

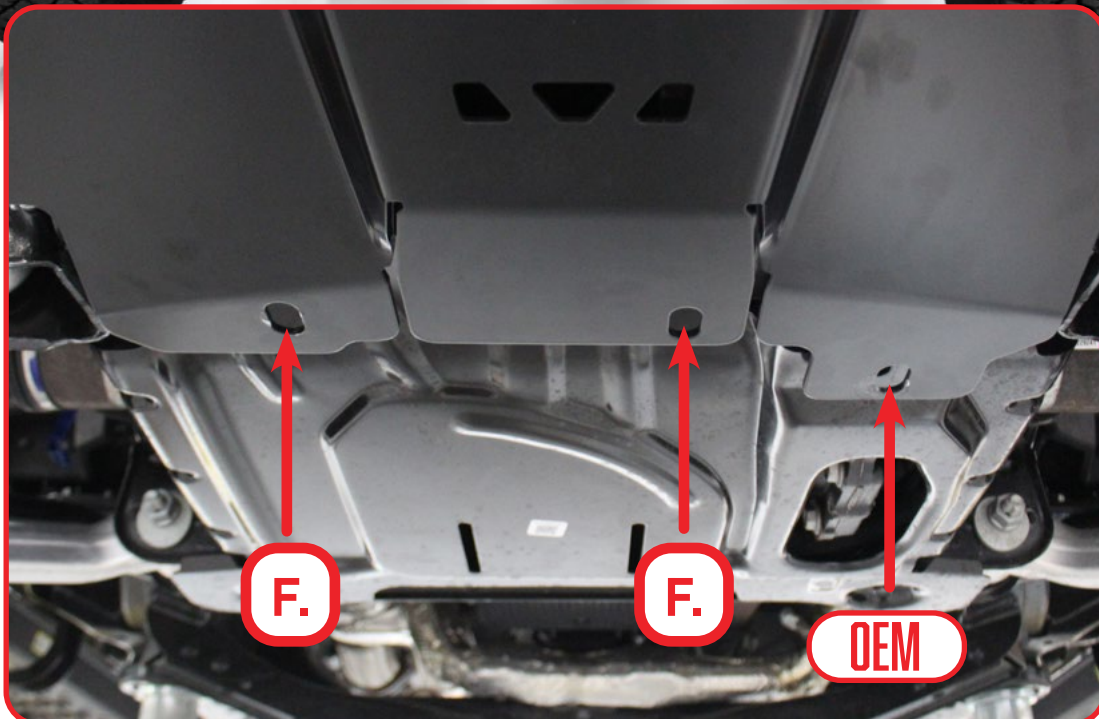



INSTALLATION GUIDE

PHANTOM FRONT BUMPER 24/FORD RANGER RAPTOR

INSTALL

□ STEP 37

Plug in the main wire harness from **step 13**. ****Check and tighten all hardware****





INSTALLATION GUIDE

PHANTOM FRONT BUMPER 24/FORD RANGER RAPTOR

FINAL

□ STEP 38

Stand back and enjoy your new ADD Phantom Front Bumper.

Check and re-tighten, if needed, all mounting bolts after 100 miles and periodically thereafter.



THIS PRODUCT IS PROTECTED BY ONE OR MORE U.S. PATENTS
WWW.ADDICTIVEDESERTDESIGNS.COM/PATENTS

FOR ADDITIONAL SUPPORT OR TECHNICAL QUESTIONS,
PLEASE CALL 480-671-0820 OR
EMAIL INFO@ADDICTIVEDESERTDESIGNS.COM