



**INSTALLATION MANUAL**  
**GRUMPER**  
**PRODUCT NUMBER: GR4700**  
**APPLICATION: 2020 FORD SD**



## **IMPORTANT SAFETY GUIDE** | Your safety and the safety of others is very important.

In order to help you make informed decisions about safety, we have provided the following warnings, safety precautions, installation instructions, and other important information to alert you to potential hazards that could hurt you or others.

Please do a job safety analysis before each task to identify potential hazards for your situation and remove/protect against them. Use own good judgment and take your time.

Check packaged materials immediately upon arrival to ensure that all listed parts are included and undamaged.

**Read and understand all warnings, safety precautions, and instructions before installing this product.**

SENSORS FIELD OF VIEW MAY BE ALTERED WITH USE OF THE REPLACEMENT BUMPER.

---

### **WARNINGS**

- Failure to observe the following warnings and instructions provided in this manual could lead to severe injury and/or death.
- For professional installation only. Careless installation and/or operation can result in serious injury, death, and/or equipment damage. All liability for installation and use rests with the user or consumer.
- Fab Fours, Inc. only approves installing this product according to these written instructions with the hardware provided. Failure to install according to these instructions will invalidate the warranty. This includes, but is not limited to, using alternative installation methods, hardware, or materials.
- This product is for off road use only.

---

### **SAFETY PRECAUTIONS**

- Always remove jewelry and wear eye protection.
- Always use extreme caution when jacking up a vehicle for work. Set emergency brake and use tire blocks. Locate and use the vehicle manufacturers designated lifting points. Use jack stands.
- Always use appropriate and adequate care in lifting components into place.
- Always ensure components will remain secure during installation and operation.
- Always wear safety glasses when installing this kit. A drilling operation will cause flying metal chips. Flying chips can cause serious eye injury.
- Always use extreme caution when drilling a vehicle. Always disconnect power before welding. Thoroughly inspect the area to be drilled (on both sides of material when possible) prior to drilling, and relocate any objects that may be damaged.
- Always use extreme caution when welding a vehicle. Thoroughly inspect the area to be welded (on both sides of material when possible) prior to welding, and relocate any objects that may be a fire hazard. When welding in a cab, make sure the interior surfaces are covered (e.g., welding blanket) and a fire extinguisher is at hand.
- Always use extreme caution when cutting and trimming during fitting.
- Always tighten all nuts and bolts securely per installation instructions.
- Always route electrical cables carefully. Avoid moving parts, components that become hot, and rough or sharp edges.
- Always insulate and protect all exposed wiring and electrical terminals.
- Perform regular inspections and maintenance on mounts and hardware.



# TABLE OF CONTENTS

2	SAFETY / DISCLAIMER
3	TABLE OF CONTENTS
4	A MESSAGE FROM THE OWNER
5	GETTING STARTED
6	PROVIDED MATERIAL
8	DISASSEMBLY
12	INSTALLATION
15	CONTACT

# A MESSAGE FROM THE OWNER

---



Fab Fours' was born out of a passion for customizing vehicles and a love of the outdoors. Our engineering team uses the latest 3D design software to turn new product ideas into reality. In our factory, designs come to life with the combination of cutting edge technology for metal cutting and forming and an American workforce that puts its' heart and pride into every product.

From design and manufacturing, to quality and delivery, Fab Fours' mission is to be the market leader for steel truck and jeep accessories. We make sure a quality product is delivered on time, more than expected, better than expected to our customers.

Enjoy your new Fab Fours product. Welcome to the family!

*Greg Higgs*

FOUNDER, FAB FOURS

# GETTING STARTED

---

Before you begin the installation process of your new Fab Fours product, we suggest laying out all materials and parts on a pad or protective surface.

Failure to fully account for all components before beginning installation may leave vehicle immobile until part is acquired. Refer to the next pages as an inventory check.

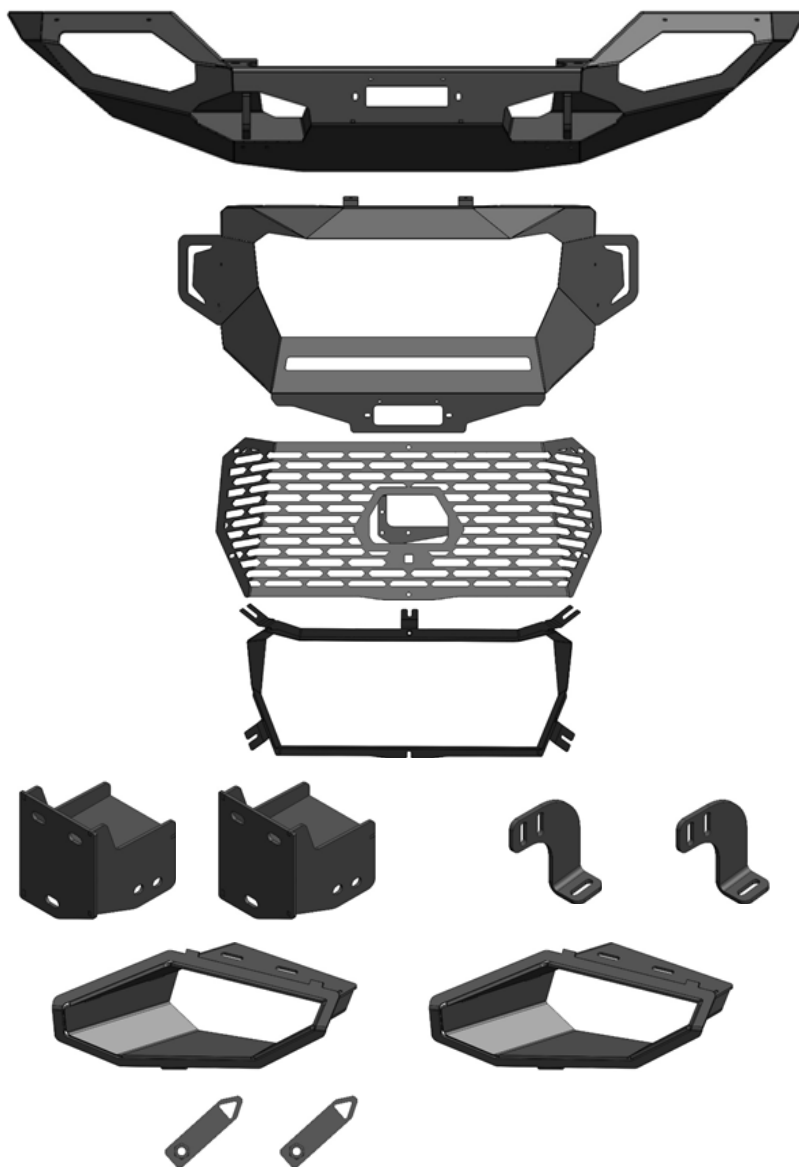

# PROVIDED MATERIALS

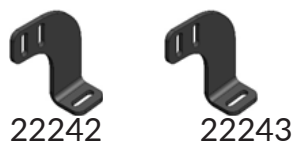
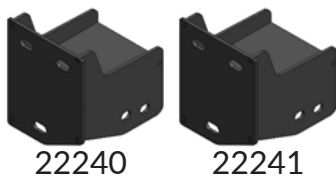
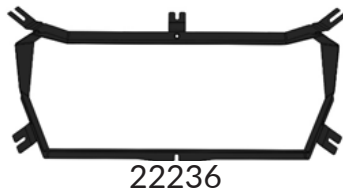
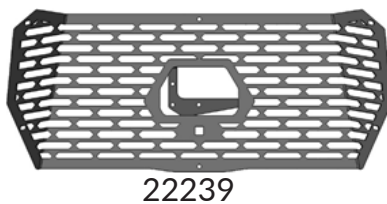
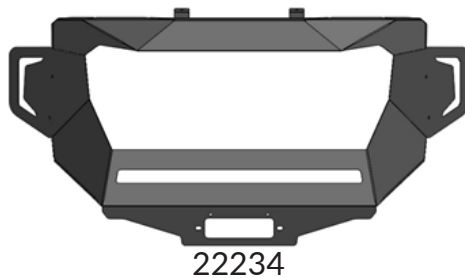
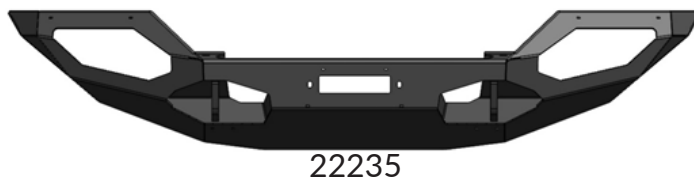

## TOOLS REQUIRED

- 10mm Socket wrench
- 15mm Socket wrench
- 18mm Socket wrench
- 3/4" Socket wrench
- 9/16" Socket wrench
- 7/16" Socket wrench
- 1/2" Socket wrench
- T6 Torx bit
- Body pry tool

## ASSISTANCE

We recommend two people perform the installation as items are heavy and may need to be held in place while installing.

## ORGANIZATION

Disassemble the vehicle where you can catalog and store everything. We suggest labeling and bagging all the OEM bolts when removing from the vehicle. Failure to keep track of parts could lead to an inability to properly reinstall components.

# PROVIDED MATERIALS

## HARDWARE KIT | 50234-HW

FAB FOURS IDENTIFICATION	COMPONENT DESCRIPTION	QTY
50234-HW	1/4"-20 x1", Yellow Zinc Hex Head Bolt, Grade 8	4
	1/4"-20, Yellow Zinc Hex Nut, Grade 8	4
	1/4" Yellow Zinc Flat Washer	8
	1/4" Yellow Zinc Lock Washer	4
	5/16"-18 x 1", Yellow Zinc Hex Head Bolt, Grade 8	7
	5/16" Stainless Steel Fender Washer	7
	5/16" Yellow Zinc Lock Washer, Grade 8	7
	7/16"-14 x 1.25", Stainless Steel Button Head Bolt	2
	7/16"-14, Stainless Steel Hex Nut	2
	7/16" Stainless Steel Flat Washer	4

FAB FOURS IDENTIFICATION	COMPONENT DESCRIPTION	QTY
50234-HW	7/16" Stainless Steel Lock Washer	2
	1/2"-13 x 1.25", Yellow Zinc Hex Head Bolt, Grade 8	6
	1/2"-13 x 2", Yellow Zinc Hex Head Bolt, Grade 8	8
	1/2"-13, Yellow Zinc Hex Nut, Grade 8	12
	1/2" Yellow Zinc Flat Washer, Grade 8	26
	1/2" Yellow Zinc Lock Washer, Grade 8	14
	3/8"-16 x 1", Yellow Zinc Hex Head Bolt, Grade 8	10
	3/8" Yellow Zinc Flat Washer, Grade 8	10
	3/8" Yellow Zinc Lock Washer, Grade 8	10
	M6 Flat Washer Stainless Steel	1
	M6 Lock Washer Stainless Steel	1
	M8 Hex Nut Stainless Steel	1
	M8 Flat Washer Stainless Steel	2
	M8 Lock Washer Stainless Steel	2



# DISASSEMBLY

*NOTE: Save all OEM parts until installation is complete!*

1. Open the hood and use a body pry tool to remove the 15 push pins holding the grill cover on. Remove the grill cover from the truck. (Figure 1)



Figure 1

2. Use a 10mm socket wrench to remove the 6 bolts on the top the grill and the 2 bolts on the back of the grill by the headlights. (Figure 2-3)

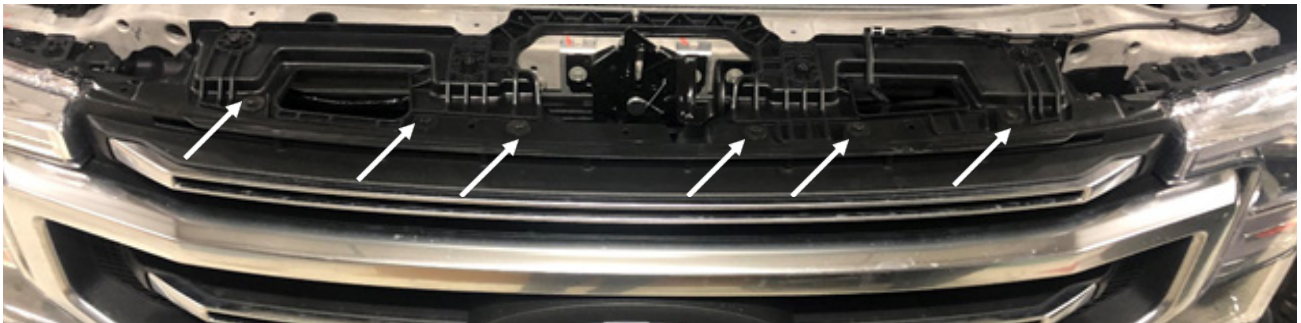

Figure 2



Figure 3



3. Remove the 2 plastic bolt covers located at the bottom of the grill by the head lights and use a 10mm socket wrench to remove the 2 bolts. Remove the grill from the truck. (Figure 4)

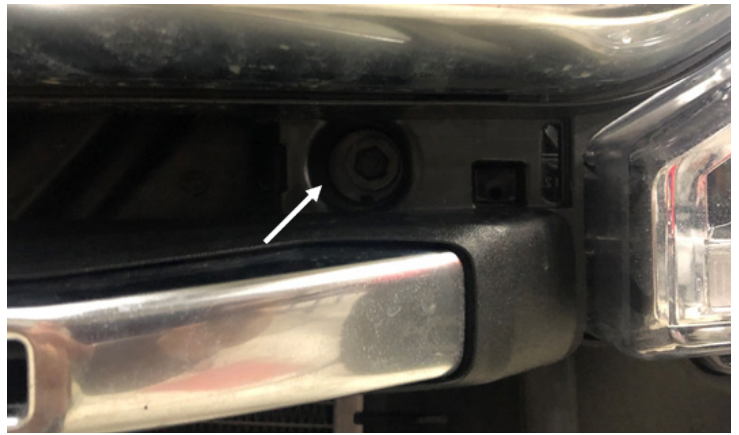

Figure 4

4. Use a body pry tool to remove the plastic tow hook covers and remove them from the truck. (Figure 5)



Figure 5

5. If equipped with adaptive cruise control: use a 10mm socket wrench to remove the sensor from the driver side tow hook pocket. (Figure 6)



Figure 6

---

6. Use a 15mm socket wrench to remove the 4 bolts on the bumper support brackets. (Figure 7)



Figure 7

7. Use an 18mm socket wrench to remove the 4 bolts holding the bumper on. Remove the bumper from the truck and remove the wiring harness from the OEM bumper for later use. (Figure 8)

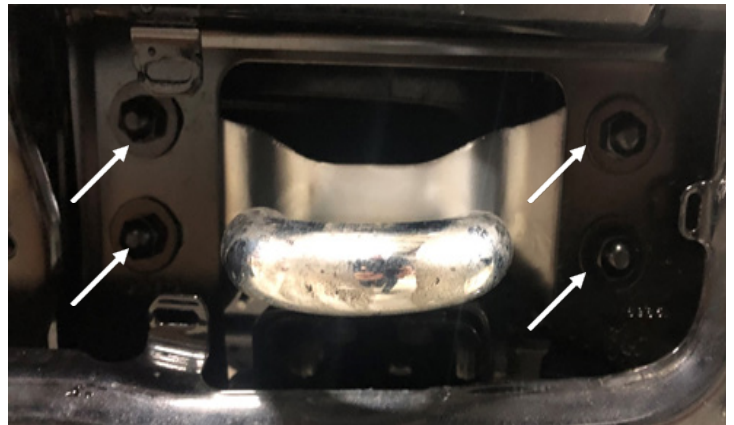

Figure 8

8. With the bumper removed: use an 18mm socket wrench to remove the 4 bolts holding the tow hooks onto the frame. (Figure 9)



Figure 9

9. Use an 18mm socket wrench to remove the 4 nuts and bolt plates from the frame guard and remove it from the truck. (Figure 10)



Figure 10

10. Use a cutting tool to remove the two 45 degree plastic gussets located at the top of the grill mount by the head lights by cutting on the lines shown below. Remove the middle grill mount by cutting on the line shown. (Figure 11-12)

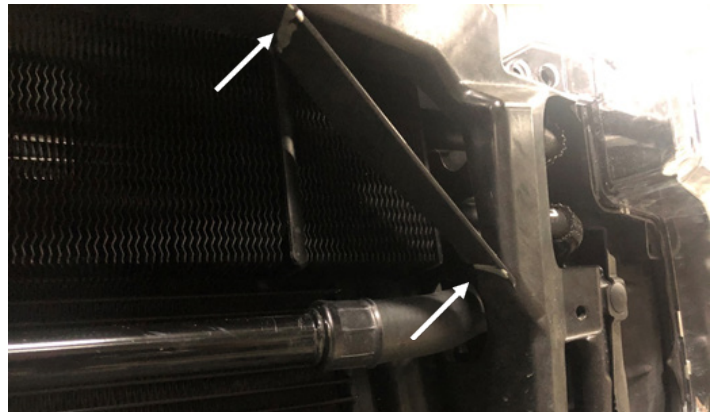

Figure 11

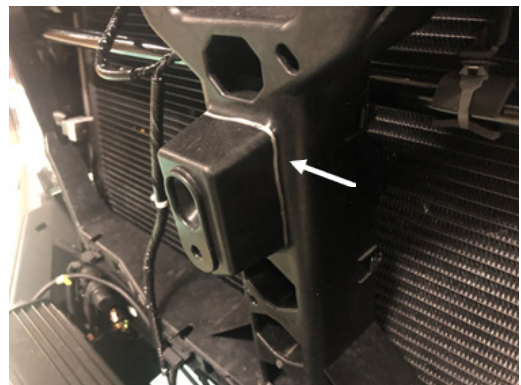

Figure 12



# INSTALLATION

11. If equipped with front camera: Use a T6 torx bit to remove the 2 bolts holding the camera housing to the grill. (Figure 13)

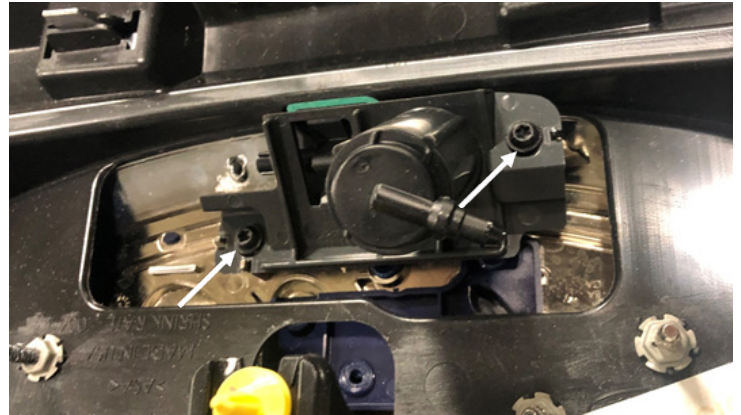

Figure 13

12. Use (3) 1/2" yellow zinc bolts, flat/lock washers and nuts for to loosely install the mounting brackets (22240-22241) to the bumper. For the lower bolt, use the provided nut plate (22244) to bolt it in (50234-HW). (Figure 14)

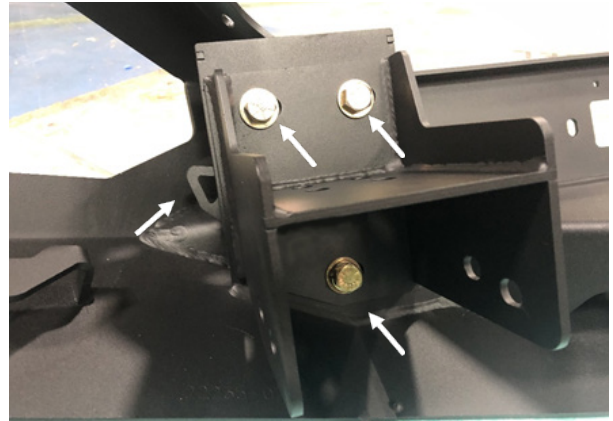

Figure 14

13. With assistance; hold the bumper up to the truck and use the OEM bolt strips removed during step 9 along with (4) 1/2" yellow zinc bolts, flat/lock washers and nuts to attach the mounting brackets to the frame rails (50234-HW). (Figure 15)

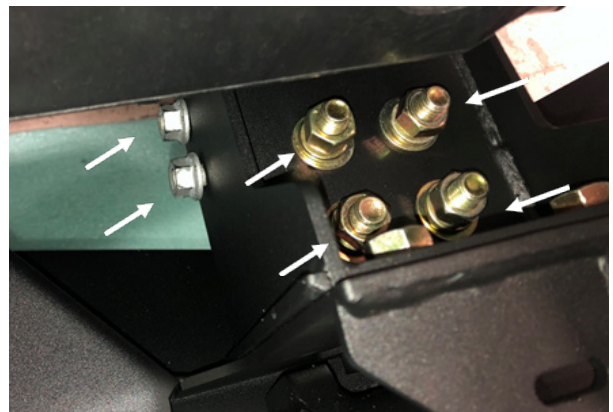

Figure 15



14. If installing a 30" light bar: Do so now using the provided mounting brackets (22242-22243) with the yellow zinc 1/4" bolts, flat/lock washers and nuts (50234-HW). (Figure 16)



Figure 16

15. Take the camera removed during step 11 and the adaptive cruise control sensor removed during step 5 and install them into the grill mesh (22239). Use the provided epoxy packets to install the camera (make sure to double check the correct orientation before you epoxy it in place). Use the M6 and M8 nuts and washers to attach the sensor into the mesh (50234-HW). (Figure 17)



Figure 17

16. Place the grill box (22236) and grill meshing (22239) into the grill (22234). Use (5) 5/16" bolts with the fender washers and lock washers to loosely install the grill box to the grill (50234-HW). Install the mesh (22239) to the grill box (22236) using the (6) 3/8" yellow zinc bolts, flat/lock washers (50234-HW). Center the grill box and fully tighten all bolts. (Figure 18)



Figure 18

# INSTALLATION

17. With assistance; hold the grill up the truck and bumper and use the (4) 3/8" yellow zinc bolts, flat/lock washers to install the grill to the bumper (50234-HW). If applicable: plug the camera and adaptive cruise control sensor into the OEM harness from the OEM bumper. (Figure 19)



Figure 19

18. Use the OEM 10mm grill mount bolts to attach the top of the Grumper grill. Attach the lower part of the grill by the fairlead mount using the (2) 7/16" Stainless Steel Button Head bolts with washers and nuts (50234-HW). (Figure 20)

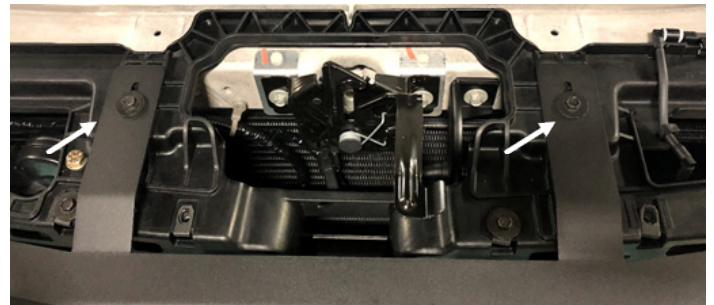

Figure 20

19. Use the 5/16" yellow zinc bolt with fender washers and lock washers to attach the light boxes (22237 and 22238) into the bumper (50234-HW). (Figure 21)

20. Fully tighten all mounting bolts and enjoy the fit and finish of your Fab Fours Grumper!



Figure 21



# CONTACT INFORMATION

**FAB FOURS INC.  
2213 INDUSTRIAL PARK ROAD  
LANCASTER, SC 29720**

**PHONE: (866) 385-1905**

**FAX: 866-574-1423**

**EMAIL: [SUPPORT@FABFOURS.COM](mailto:SUPPORT@FABFOURS.COM)**

**[WWW.FABFOURS.COM](http://WWW.FABFOURS.COM)**



---

**“IF YOU’RE LOOKING FOR MORE OF THE SAME,  
THEN YOU’VE COME TO THE WRONG PLACE.”**

**- GREG HIGGS**

