



INSTALLATION MANUAL
PREMIUM REAR BUMPER
PRODUCT NUMBER: W4951
APPLICATION: 2020 CHEVROLET HD



IMPORTANT SAFETY GUIDE | Your safety and the safety of others is very important.

In order to help you make informed decisions about safety, we have provided the following warnings, safety precautions, installation instructions, and other important information to alert you to potential hazards that could hurt you or others.

Please do a job safety analysis before each task to identify potential hazards for your situation and remove/protect against them. Use own good judgment and take your time.

Check packaged materials immediately upon arrival to ensure that all listed parts are included and undamaged.

Read and understand all warnings, safety precautions, and instructions before installing this product.

SENSORS FIELD OF VIEW MAY BE ALTERED WITH USE OF THE REPLACEMENT BUMPER.

WARNINGS

- Failure to observe the following warnings and instructions provided in this manual could lead to severe injury and/or death.
- For professional installation only. Careless installation and/or operation can result in serious injury, death, and/or equipment damage. All liability for installation and use rests with the user or consumer.
- Fab Fours, Inc. only approves installing this product according to these written instructions with the hardware provided. Failure to install according to these instructions will invalidate the warranty. This includes, but is not limited to, using alternative installation methods, hardware, or materials.
- This product is for off road use only.

SAFETY PRECAUTIONS

- Always remove jewelry and wear eye protection.
- Always use extreme caution when jacking up a vehicle for work. Set emergency brake and use tire blocks. Locate and use the vehicle manufacturers designated lifting points. Use jack stands.
- Always use appropriate and adequate care in lifting components into place.
- Always ensure components will remain secure during installation and operation.
- Always wear safety glasses when installing this kit. A drilling operation will cause flying metal chips. Flying chips can cause serious eye injury.
- Always use extreme caution when drilling a vehicle. Always disconnect power before welding. Thoroughly inspect the area to be drilled (on both sides of material when possible) prior to drilling, and relocate any objects that may be damaged.
- Always use extreme caution when welding a vehicle. Thoroughly inspect the area to be welded (on both sides of material when possible) prior to welding, and relocate any objects that may be a fire hazard. When welding in a cab, make sure the interior surfaces are covered (e.g., welding blanket) and a fire extinguisher is at hand.
- Always use extreme caution when cutting and trimming during fitting.
- Always tighten all nuts and bolts securely per installation instructions.
- Always route electrical cables carefully. Avoid moving parts, components that become hot, and rough or sharp edges.
- Always insulate and protect all exposed wiring and electrical terminals.
- Perform regular inspections and maintenance on mounts and hardware.

TABLE OF CONTENTS

- 2 SAFETY / DISCLAIMER
- 3 TABLE OF CONTENTS
- 4 A MESSAGE FROM THE OWNER
- 5 GETTING STARTED
- 6 PROVIDED MATERIAL
- 7 DISASSEMBLY
- 11 INSTALLATION
- 14 CONTACT

A MESSAGE FROM THE OWNER



Fab Fours' was born out of a passion for customizing vehicles and a love of the outdoors. Our engineering team uses the latest 3D design software to turn new product ideas into reality. In our factory, designs come to life with the combination of cutting edge technology for metal cutting and forming and an American workforce that puts its' heart and pride into every product.

From design and manufacturing, to quality and delivery, Fab Fours' mission is to be the market leader for steel truck and jeep accessories. We make sure a quality product is delivered on time, more than expected, better than expected to our customers.

Enjoy your new Fab Fours product. Welcome to the family!

Greg Higgs

FOUNDER, FAB FOURS

GETTING STARTED

Before you begin the installation process of your new Fab Fours product, we suggest laying out all materials and parts on a pad or protective surface.

Failure to fully account for all components before beginning installation may leave vehicle immobile until part is acquired. Refer to the next pages as an inventory check.

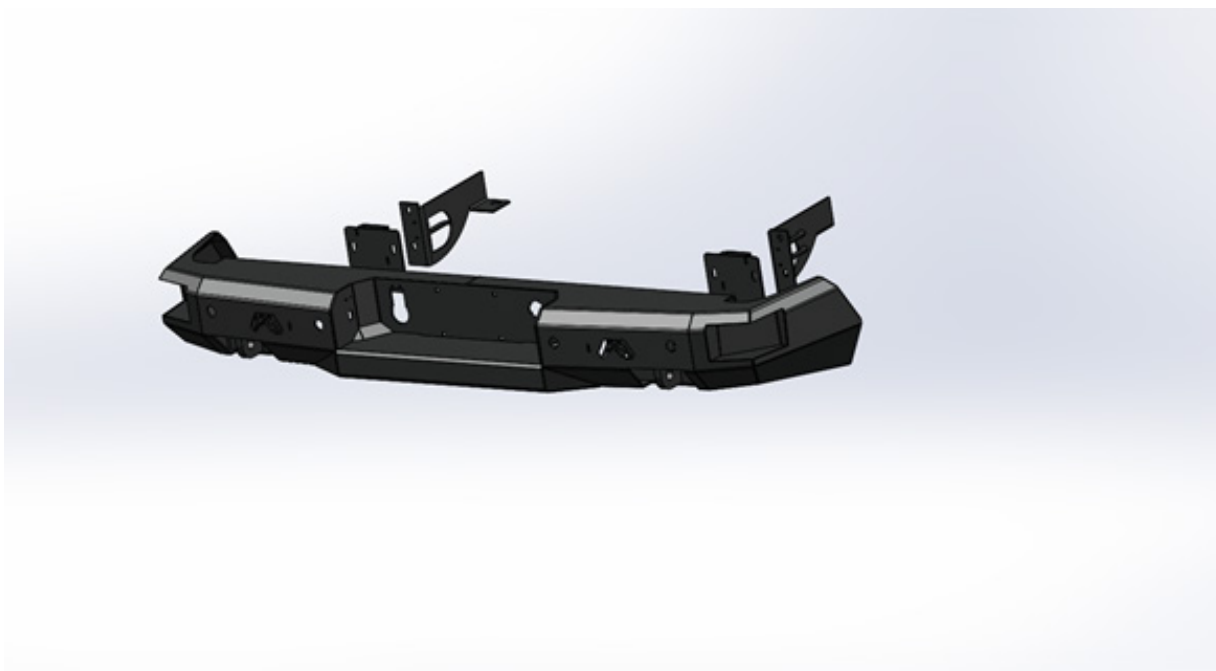

PROVIDED MATERIALS

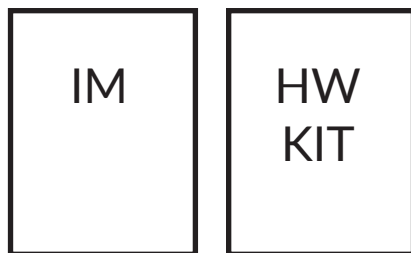

W4951-IM 50227-HW



22162

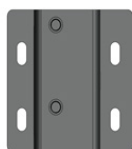

22163-W



22165-W



22164-W



22166-W

HARDWARE KIT | 50227

FAB FOURS IDENTIFICATION	COMPONENT DESCRIPTION	QTY
50227-HW	1/2" License Plate nut , Auveco, 11719	4
50227-HW	1/2"-13 x 2", HHCS , Zinc, GR8	8
50227-HW	1/2"-13, x , Hex Nut , Zinc, GR8	8
50227-HW	1/2 SAE FLAT WASHER STL ZINC	20
50227-HW	1/2"-SAE x , Lock Washer , Zinc, GR8	10
50227-HW	Plastic Plug	4
50227-HW	1 3/8"- x , Grommet , Plastic, mm9307K81	4
50227-HW	1/2"-13 x 1.5", HHCS , Zinc, GR8	4

TOOLS REQUIRED

- Plastic panel pry tool
- 7mm socket wrench
- 13mm socket wrench
- 15mm socket wrench
- 18mm socket wrench
- 3/32 allen wrench
- 3/4" socket wrench
- 9mm socket wrench
- Flat head screw driver

ASSISTANCE

We recommend two people perform the installation as items are heavy and may need to be held in place while installing.

ORGANIZATION

Disassemble the vehicle where you can catalog and store everything. We suggest labeling and bagging all the OEM bolts when removing from the vehicle. Failure to keep track of parts could lead to an inability to properly reinstall components.

DISASSEMBLY

1. From under the truck unplug all wire harnesses including sensor, keyless entry, trailer plug and camera. (Figure 1 & 2)

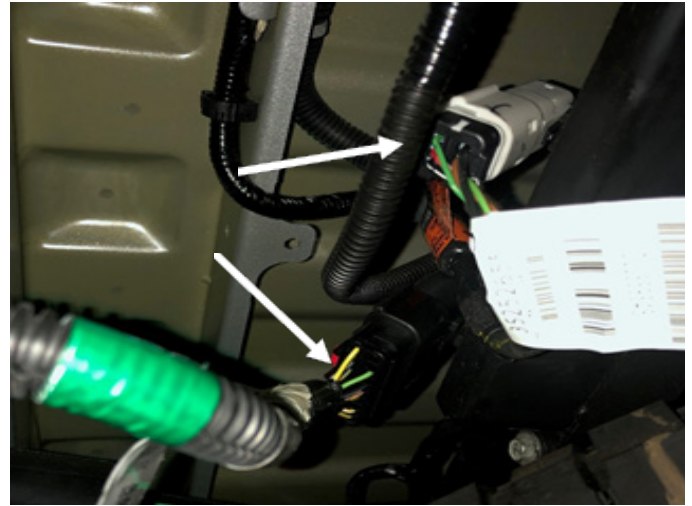

Figure 1



Figure 2

2. Use a 15mm socket wrench to remove the outside support bracket bolt on the driver and passenger sides. (Figure 3)



Figure 3

3. Use a 13mm socket wrench to remove the two bolts from behind the license plate. (Figure 4)



Figure 4

4. Use an 18mm socket wrench to remove the two (2) nuts from the mounting plate on both the driver and passenger side. With assistance, remove the bumper from the truck. (Figure 5)

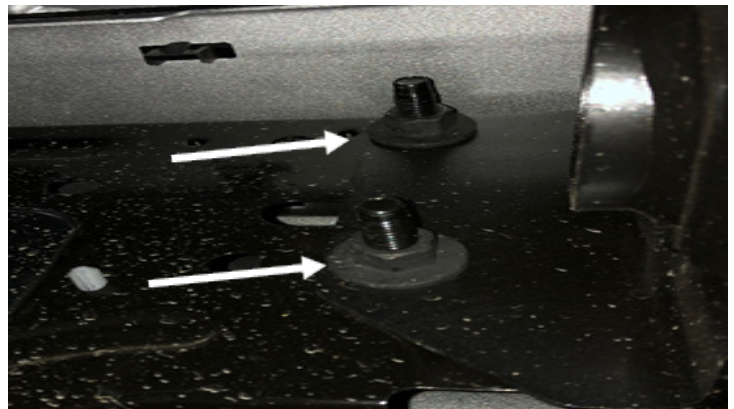

Figure 5

5. With the bumper, press in the two clips on the trailer plug and push out to remove it from the bumper. (Figure 6)

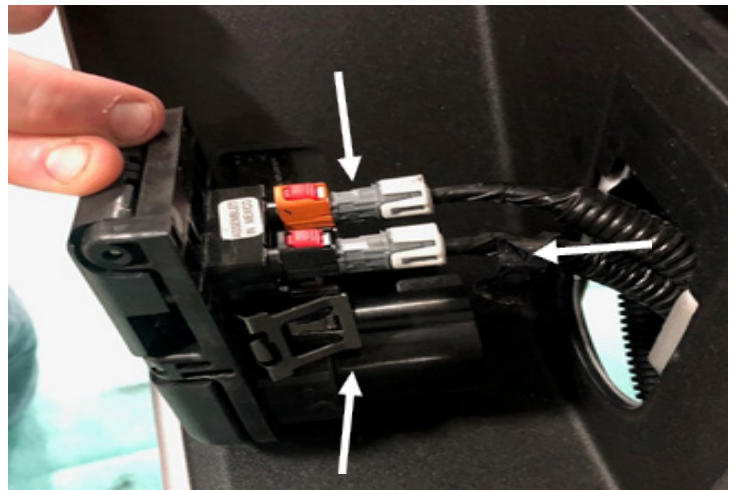

Figure 6

6. Remove the spare tire lock by pressing the clips in and pushing out. (Figure 7)

****Please note that the Blind Spot Monitor is not compatible with the Fab Fours bumper so it is not necessary to remove from OEM bumper and re-install****



Figure 7

9. Use a 7mm socket wrench to remove the two license plate lights from the OEM bumper. To unplug the lights, turn the connector counterclockwise. (Figure 8)

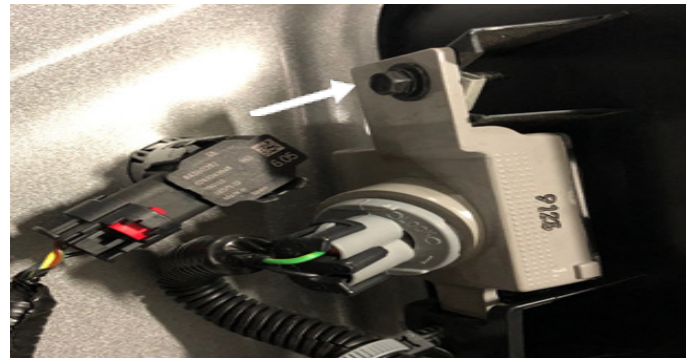

Figure 8

10. Using a body pry tool, remove the threaded clip by inserting the body pry tool and pull up on the clip. (Figure 9)

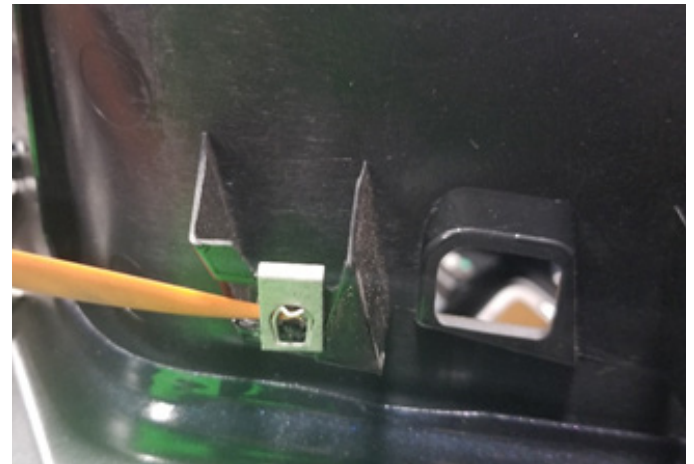

Figure 9

NOTE Label each sensor housing as it is removed to ensure it is placed back in the correct position when reinstalled back into the Fab Fours bumper.

11. To remove the four (4) sensors: Carefully spread the housing clips and push the sensor out of the housing (Figure 10). With the sensor removed, press the four (4) tabs in and push the housing out of the bumper. (Figure 11)

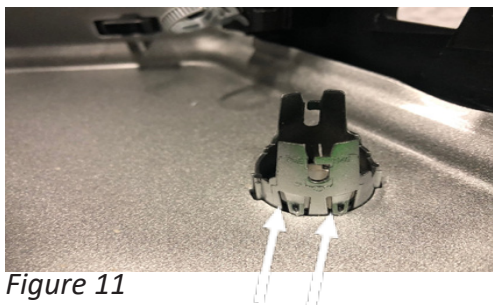

Figure 11



Figure 10

INSTALLATION

12. Remove the keyless entry sensor from behind the license plate by pressing in the three (3) clips and pushing it out. (Figure 12)

13. Remove the sensor harness from the bumper by unclipping it and set it aside for later use.

14. Install the keyless entry sensor to the license plate bracket using zip ties. The sensors can now be plugged in. (Figure 13)

15. Install your OEM sensor housing and feed your OEM wiring harness through your new bumper. Epoxy your sensors into to place, and once the epoxy cures, install your factory sensors in the housings as shown. (Figure 14)

16. Install the factory threaded clip from your OEM tag light into your new Fab Fours bumper and insert your OEM tag light into the retaining bracket. Use the factory screw to secure it. (Figure 15)

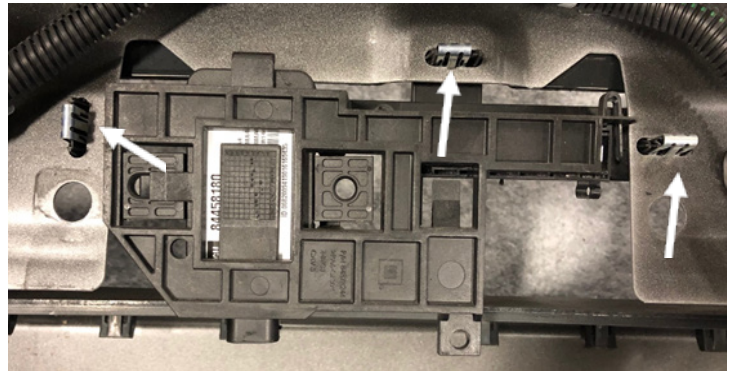

Figure 12



Figure 13



Figure 14

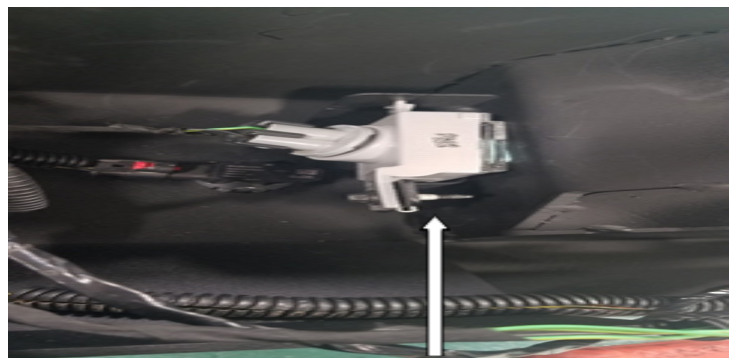

Figure 15

17. Remove the 21mm bolts from the bottom of the frame. (Figure 16)



Figure 16

18. Using the bolt removed in step 15, install the secondary brackets (22164-W and 22166-W) on each side. Do not tighten this bolt yet. (Figure 17)



Figure 17

19. Install the intermediate brackets on to the secondary brackets using two ½-13 x1.5” bolts, flat washers and lock washers for each side. Make sure that the intermediate bracket is installed correctly. (Figure 18)

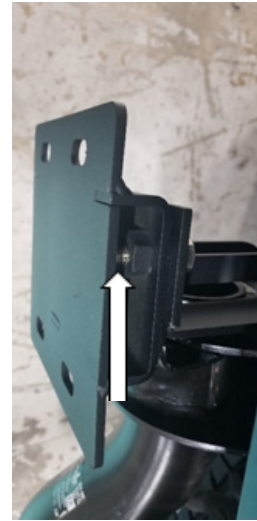

Figure 18

20. With assistance, lift your new Fab Fours bumper into place and using the eight supplied ½-13 x 2” bolt stacks in hardware kit 50227-HW install your new bumper.

21. Ensure your bumper is centered and clears your tailgate then tighten all bolts down.

22. Ensure all wires and sensors are plugged back in.

CONTACT INFORMATION

**FAB FOURS INC.
2213 INDUSTRIAL PARK ROAD
LANCASTER, SC 29720**

PHONE: (803) 416-1100

FAX: 970-385-1914

EMAIL: SUPPORT@FABFOURS.COM

WWW.FABFOURS.COM



**“IF YOU’RE LOOKING FOR MORE OF THE SAME,
THEN YOU’VE COME TO THE WRONG PLACE.”**

- GREG HIGGS

